



**Biotechnology Explorer<sup>®</sup>**  
**Green Fluorescent Protein (GFP)**  
**Purification Kit**

**Catalog Number**  
**166-0005-EDU**

**[www.bio-rad.com](http://www.bio-rad.com)**

**BIO-RAD**

## **A Complete Teaching Guide**

Developed over five years, Biotechnology Explorer kits and curricula have been written for teachers, by teachers, and have been extensively field-tested in a broad range of classroom settings from high school through the undergraduate level. Easy-to-use Biotechnology Explorer kits are the perfect way to bring the excitement of biotechnology into the classroom. Each kit contains an innovative step by step protocol, which makes them the perfect choice for both experts and beginning teachers.

The curriculum contained within the manual for each kit makes our products unique. Each kit contains its own unique curriculum package which is divided into a Teachers Guide and Student Manual. The Teachers Guide is divided into three sections which help to insure that the labs run smoothly. One section contains background information, lecture topics, and suggested references which will enable each teacher, both experienced and newcomers to biotechnology, to prepare and design lectures and lessons which can precede the actual labs. This advance preparation will virtually insure that the labs run smoothly and that the students understand the concepts behind each lab. There is a detailed section on the laboratory set up, complete with simple procedures which contain graphic diagrams detailing the advance preparation for the labs. This makes the set up for each lab virtually foolproof. In addition, this section contains time tables which will help you plan your schedule accordingly. Each lab can be performed in a 50 minute time period, which should fit into most schedules.

Finally, we provide a detailed Teachers Answer Guide which contains answers to all of the questions posed in the Student Manual. The teacher can use these answers as a guide when reviewing or grading the questions presented in the Student section of the manual.

Each kit is designed to maximize student involvement in both the labs and the thought questions embedded in the manual. Student involvement in this process results in an increased understanding of the scientific process and the value of proceeding into a task in an organized and logical fashion. Students who engage in the science curriculum found in the Bio-Rad explorer kits develop a positive sense of their ability to understand the scientific method.

In order for your students to gain the most from this experiment they should know what a gene is and understand the relationship between genes and proteins. For a more detailed discussion of these and other basic molecular biology concepts and terms, refer to the review provided in Appendix B.

We strive to continually improve our curriculum and products. Your input is extremely important to us. Incorporation of your ideas, comments, critiques, and suggestions will enable the explorer products to evolve into even better teaching aids.

You can find the catalog and curriculum on the internet. Look up our home page at [www.bio-rad.com](http://www.bio-rad.com) or call us at 1-800-424-6723.

Ron Mardigian  
Product Manager, Biotechnology Explorer Program  
[ron\\_mardigian@bio-rad.com](mailto:ron_mardigian@bio-rad.com)

# Table of Contents

<b>Instructors Guide</b>		<b>Page</b>
Kit Inventory Check List	Kit Components and Required Accessories .....	2
Suggested Lesson Flow	Planning Your Week .....	4
Workstation Check List	Student and Instructor Lab Set-ups .....	5
Implementation Timeline	Advanced Prep and Student Lessons .....	6
Lesson Highlights	Detailed Instructors Guide.....	9
Quick Guide	Graphic Laboratory Protocol.....	16
Teacher Answer Guide	Answers to Student Review Questions .....	20
<b>Student Manual</b>		
Green Fluorescent Protein (GFP) Purification.....		26
Lesson 1	Genetic Transformation Review: Finding the Green Fluorescent Molecule .....	27
Lesson 2	Inoculation Growing a Cell Culture.....	28
Lesson 3	Purification Phase 1 Bacterial Concentration and Lysis .....	32
Lesson 4	Purification Phase 2 Removing Bacterial Debris .....	36
Lesson 5	Purification Phase 3 Protein Chromatography.....	39
<b>Appendices</b>		
Appendix A	Glossary of Terms .....	43
Appendix B	Molecular Biology Concepts and Terminology .....	47
Appendix C	Sterile Technique, Working with <i>E. coli</i> and Disposal of Biological Waste .....	52
Appendix D	Gene Regulation and Genetic Selection .....	53

## Is Finding a Needle in a Hay Stack Easier When it Glows?

This laboratory activity is designed to follow Biotechnology Explorer Kit 1, “Bacterial Transformation—the pGLO System” (catalog number 166-0003-EDU). Students begin this activity with the bacteria they genetically transformed using the plasmid, pGLO. Transformed bacteria which produce the genetically engineered Green Fluorescent Protein (GFP) are removed from their agar plates and allowed to multiply in liquid nutrient media. The bacterial cells are then broken open (lysed) to release the Green Fluorescent Protein. GFP is subsequently purified from the contaminating bacterial debris using the disposable chromatography columns provided in this kit. The unique fluorescent properties of GFP allow the entire process to be observed using a long wavelength UV lamp (*i.e.* pocket geology lamp).

One of the basic tools of modern biotechnology is DNA splicing, cutting DNA and linking it to other DNA molecules. The basic concept behind DNA splicing is to remove a functional DNA fragment—let’s say a gene—from one organism and combine it with the DNA of another organism in order to make the protein that gene codes for. The desired result of gene splicing is for the recipient organism to carry out the genetic instructions provided by its newly acquired gene. For example, certain plants can be given the genes for resistance to pests or disease, and in a few cases to date, functional genes can be given to people with non-functional or mutated genes, such as in a genetic disease like cystic fibrosis.

Genes can be cut out of human, animal, or plant DNA and placed inside bacteria. For example, a healthy human gene for the hormone insulin can be put into bacteria. Under the right conditions, these bacteria can make authentic human insulin. When allowed to multiply in gigantic vats (fermenters) these bacteria can be used to mass produce the human insulin protein. This genetically engineered insulin is purified using protein chromatography and used to treat patients with the genetic disease, diabetes, whose insulin genes do not function normally.

A common problem in purifying genetically engineered “designer” proteins from transformed bacteria is contamination by endogenous bacterial proteins. Chromatography is a powerful method used in the biotechnology industry for separating and purifying proteins of interest from bacterial proteins. Proteins purified in this manner can then be used, for example, as medicines to treat human disease, or, for household agents such as natural enzymes to make better laundry detergents.

The cloning and expression of the GFP gene (pGLO Transformation Kit 1), followed by the purification of its protein in kit 2, is completely analogous to the processes used in the biotechnology industry to produce and purify proteins with commercial value. The real-life source of the Green Fluorescent Protein gene is the bioluminescent jellyfish *Aequoria victoria*. In this exercise, you may suggest a hypothetical scenario to your students in which GFP has some special commercial value and its gene comes from a different natural source, plant or animal. In either case, the principle is exactly the same, the gene codes for a Green Fluorescent Protein.

*“Bioengineered DNA was, weight for weight, the most valuable material in the world. A single microscopic bacterium, too small to see with the human eye, but containing the gene for a heart attack enzyme, streptokinase, or for “ice-minus” which prevented frost damage to crops, might be worth 5 billion dollars to the right buyer.”*

**- Michael Crichton - Jurassic Park**

## Instructors Guide

### Kit Inventory (✓) Checklist

This section lists the components provided in the GFP Purification Kit. It also lists required accessories. Each kit contains sufficient materials to outfit eight student workstations. Use this as a checklist to inventory your supplies before beginning the experiments.

<b>Components Provided with the Kit</b>	<b>Number/Kit</b>	<b>(✓)</b>
Ampicillin—lyophilized	1 vial	<input type="checkbox"/>
Arabinose—lyophilized	1 vial	<input type="checkbox"/>
LB-broth tablet (to make 50 milliliters)	1 tablet	<input type="checkbox"/>
Inoculation loops—packs of 10 loops	2 pk	<input type="checkbox"/>
Pipettes—sterile, individually wrapped	40	<input type="checkbox"/>
Microtubes—2.0 milliliters, clear	30	<input type="checkbox"/>
Culture tubes—15 milliliters, sterile (pack of 25)	1 pk	<input type="checkbox"/>
Collection tubes—5 milliliters, polystyrene	25	<input type="checkbox"/>
TE buffer (10 mM Tris, 1 mM EDTA, pH 8.0; sterile)	1 bottle	<input type="checkbox"/>
Lysozyme—lyophilized	1 vial	<input type="checkbox"/>
Binding Buffer (4 M NH <sub>4</sub> SO <sub>4</sub> /TE, pH 8.0)	1 bottle	<input type="checkbox"/>
Column Equilibration Buffer (2M NH <sub>4</sub> SO <sub>4</sub> /TE, pH 8.0)	1 bottle	<input type="checkbox"/>
Column Wash Buffer (1.3 M NH <sub>4</sub> SO <sub>4</sub> /TE, pH 8.0)	1 bottle	<input type="checkbox"/>
HIC chromatography columns	8	<input type="checkbox"/>
Column end caps	1 bag	<input type="checkbox"/>
Foam microtube rack	8	<input type="checkbox"/>

<b>Accessories Not Included in the Kit</b>	<b>Number/Class</b>	<b>(✓)</b>
Transformation plates (Kit 1–LB/amp and LB/amp/ara)	2	<input type="checkbox"/>
UV lamp - Long Wavelength* Bio-Rad catalog number 166-0500-EDU	1–4	<input type="checkbox"/>
Microwave oven	1	<input type="checkbox"/>
1 liter flask	1	<input type="checkbox"/>
250 milliliter flask	1	<input type="checkbox"/>
100 milliliter and 250 milliliter graduated cylinder	1	<input type="checkbox"/>
Distilled water (1 gallon container from supermarket)		
Thermometer	1	<input type="checkbox"/>
Centrifuge	1	<input type="checkbox"/>
Beaker of water for rinsing pipettes	1	<input type="checkbox"/>
Bleach	10 milliliters	<input type="checkbox"/>
Magic Markers	1	<input type="checkbox"/>
Refrigerator freezer	1	<input type="checkbox"/>

### **Optional**

Shaking/Rocking Platform or Incubator Use of a rocker or shaker will speed bacterial growth in liquid cultures, but is not required.	1	<input type="checkbox"/>
--	---	--------------------------

### **\*UV lamp**

Ultraviolet radiation can cause damage to eyes and skin. Short-wave UV is more damaging than long-wave UV light. The Bio-Rad UV lamp recommended for this module is long-wave. If possible, use UV-rated safety glasses or goggles.

## Suggested Lesson Flow

There are five lessons in the GFP Purification Kit curriculum, including four active student laboratory sessions. All lessons are designed to be carried out in consecutive 50 minute periods. For continuity, the five lessons can be conveniently started on a Monday and completed on a Friday. Step by step protocols employed in the student labs are detailed in the Student Manual.

**Lesson 1** Introduction to Purification. Lecture and discussion.

**Lesson 2** Picking Colonies and Inoculating Cell Cultures

**Lesson 3** Purification Phase 1—Bacterial Concentration and Lysis

**Lesson 4** Purification Phase 2—Removing Bacterial Debris

**Lesson 5** Purification Phase 3—Protein Chromatography

## Advance Preparation Instructors Overview

This section outlines the recommended schedule for advance preparation on the part of the instructor. A detailed advance preparation guide begins on page 6.

<b>Prep Activity</b>	<b>When</b>	<b>Time required</b>
Read manual	Immediately	1 hour
Prepare Liquid Culture Media	Before Lesson 2	15 minutes
Set up Workstations	Day of each lesson	5 minutes/day

## Workstations Daily Inventory Check (✓) List

### Student Workstations

Materials and supplies that should be present at each student workstation site prior to beginning each lab activity are listed below. The components provided in this kit are sufficient to outfit 8 complete student workstations.

### Instructors (Common) Workstation

Materials, supplies, and equipment that should be present at a common location that can be accessed by all students during each lab activity are also listed below. It is up to the discretion of the teacher as to whether students should access common buffer solutions/equipment, or whether the teacher should aliquot solutions and operate equipment.

<b>Lesson 2</b>		<b>Lesson 4</b>	
<b>Student workstations</b>	<b>Number/team</b>	<b>Student workstations</b>	<b>Number/team</b>
Transformation plates from Kit 1 (LB/amp/ara and LB/amp)	2	Microtubes	1
Inoculation loops	2	Pipette	1
Culture tubes containing 2 ml growth media	2	Microtube rack	1
Marking pen	1	Marker	1
Test tube holder	1–4	Beaker of water for rinsing pipettes	1
		HIC chromatography column	1
		Column end cap	1
<b>Instructors workstation</b>		<b>Instructors workstation</b>	
Shaking incubator or platform (optional)	1	Binding Buffer	1 vial
UV light	1–4	Equilibration Buffer	1 vial
		Centrifuge	1
		UV light	1–4
<b>Lesson 3</b>		<b>Lesson 5</b>	
<b>Student workstations</b>		<b>Student workstations</b>	
Microtubes	1	Collections tubes	3
Pipettes	1	Pipette	1
Microtube rack	1	Microtube rack	1
Marker	1	Marker	1
Beaker of water for rinsing pipettes	1	Beaker of water for rinsing pipettes	1
<b>Instructors workstation</b>		HIC chromatography column	1
TE solution	1 vial	Column end cap	1
Lysozyme (rehydrated)	1 vial	<b>Instructors workstation</b>	
Centrifuge	1	Wash Buffer	1 vial
UV light	1–4	Equilibration Buffer	1 vial
		TE Buffer	1 vial
		UV light	1–4



## Instructors Advance Preparation for Labs

This section describes preparation to be performed in advance by the instructor for the active lab sessions in Lessons 2 through 5.

- Lesson 2** Inoculation—Growing a Cell Culture
- Lesson 3** Purification Phase 1—Bacterial Concentration and Lysis
- Lesson 4** Purification Phase 2—Removing Bacterial Debris
- Lesson 5** Purification Phase 3—Protein Chromatography

For students to begin Lesson 2 they will need the two transformation plates (LB/amp/ara and LB/amp) from Kit 1. To avoid contamination, bacterial cells from these plates should be used within 3 days following the transformation activity. At the completion of the transformation activity, store the transformation plates in a refrigerator to keep the cells fresh.

### Lesson 2 Inoculation—Growing a Cell Culture

#### Advance Preparation

- Objectives** Prepare liquid culture media (6–8 below)  
Set up student and instructors workstations (Page 5)  
Set up rocking table or shaking incubator or incubator oven
- Time Required** 30 minutes

**Note: Observe sterile technique while preparing the following materials. See Appendix C.**

#### Prepare Ampicillin and Arabinose Solutions

Ampicillin and arabinose are shipped dry in small vials. After being rehydrated, both are added to the liquid growth media. Ampicillin is an antibiotic which inhibits growth of bacterial contaminants which may be introduced from the environment. Arabinose is a sugar which induces the overexpression of the Green Fluorescent Protein in cloned cells. Refer to Appendix A and D for more details on the functions of these two components.

Using a sterile pipette, add 3 milliliters of TE Solution directly to the vial containing the ampicillin. Using another sterile pipette, add 3 milliliters of TE Solution to rehydrate the arabinose. Mix the vials and gently swirl or vortex to aid in rehydration.

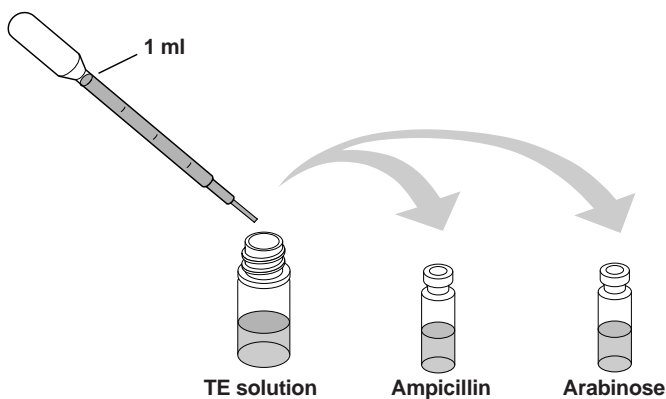

**Note:** Rehydrate ampicillin and arabinose the day you prepare the liquid growth medium. Arabinose requires 10 minutes to dissolve—be patient.

## Prepare Liquid Nutrient Media

In Lesson 2, each student workstation will require two culture tubes containing 2 milliliters of liquid nutrient media. These will be used to grow bacterial cultures. To prepare the liquid media, add 55 milliliters of distilled water to a 250 Erlenmeyer flask and heat to boiling in a microwave. Then, add the single LB tablet to the flask. Let the tablet soak in the hot water for 20 minutes; this will aid in dissolving. Heat the flask again to boiling in the microwave. Swirl the flask to dissolve the tablet. Repeat heating and swirling several times until the entire tablet is dissolved, but be careful to allow the flask to cool a little before swirling so that the hot medium does not boil over onto your hand.

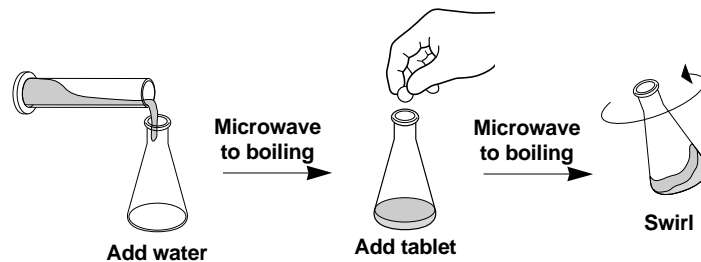

When the entire tablet is dissolved, allow the LB to cool so that the outside of the flask is comfortable to hold, or below 50 °C. While the media is cooling, get the ampicillin and arabinose solutions that were prepared in step 1 above. When the media has cooled, use a new pipette and transfer 0.5 milliliters of arabinose and 0.5 ml of ampicillin into the flask. Swirl the flask to mix the components. You can now discard the residual arabinose and ampicillin solutions.

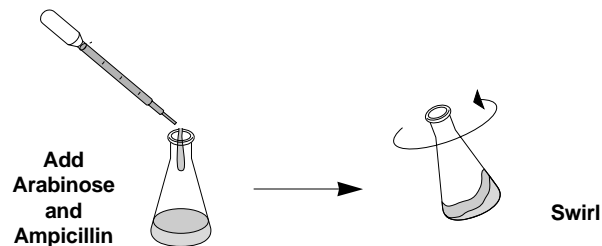

## Aliquot Liquid Culture Media

Using a new pipette as above, aliquot 2 milliliters of the liquid media into 16 culture tubes. (This can be accomplished by transferring the media in two 1 milliliter aliquots from a sterile pipette.) Store the culture tubes in a refrigerator until the day of use. Nine extra culture tubes are provided. You may wish to fill these tubes with media and use them for demonstrations or for backup liquid cultures for those student teams that do not have successful growth.

For Lesson 2, each student workstation will need two 15 milliliter culture tubes, each containing 2 milliliters of liquid culture media. In this lesson, students inoculate their 2 milliliter cultures with transformed bacteria from Kit 1.

**Note:** Vigorous shaking of the liquid cell cultures provides more oxygen to the dividing cells, allowing them to multiply faster. A shaking incubator aids in this process. If such a device is not available, cell cultures may be shaken manually for 30 seconds and incubated at 32 °C for 24 hours. Simply have the students shake the capped culture tubes for 30 seconds, as they would a can of spray paint. The more vigorous the manual shaking, the more growth, which results in greater production of GFP. After shaking, lay the tubes on their sides in the incubator oven for 1–2 days. When the tubes are oriented horizontally, more surface area of the culture media is exposed to the air in the tube, allowing more oxygen to diffuse into the cells. Shake periodically during the 2 day incubation.

If a rocking table, shaking water bath, or orbital shaker is available, adjust the device to run between 40 to 200 RPM. Again, the more vigorous the shaking the better. Shaking at 32 °C will provide sufficient bacterial growth in under 24 hours. Cells will also grow sufficiently at room temperature (with rocking). Stationary cultures are not recommended for room-temperature growth. In either case, following the appropriate incubation period, cell cultures inoculated with white and green transformed colonies should appear bright green under ultraviolet light.

### **Lesson 3 Purification Phase 1 Bacterial Concentration and Lysis**

#### **Advance Preparation**

**Objective**                      Set up workstations  
   Rehydrate lysozyme  
   Set up centrifuge

**Time required**                10 minutes

Rehydrate the vial of lyophilized lysozyme with 1 milliliter of TE solution using a new pipette. Mix gently to aid in the resuspension. Keep the vial of lysozyme on ice or in a refrigerator until use.

### **Lesson 4 Purification Phase 2 Removing Bacterial Debris**

**Objective**                      Set up workstations (the only preparation needed)  
   Set up centrifuge

**Time required**                10 minutes

### **Lesson 5 Purification Phase 3 Protein Chromatography**

**Objective**                      Set up workstations (the only preparation needed)

**Time required**                10 minutes

## Lesson Points to Highlight

This section describes steps in the experimental protocols which may be technically challenging or which are extremely important to the overall outcome and understanding of the experiments. Instructors should alert their students attention to these points, and when possible, demonstrate the technique before the students attempt the procedure.

The Student Manual contains the detailed descriptions and drawings of all laboratory steps and the techniques employed in Lessons 2–5. Refer to it for questions about the experimental protocols used in lab.

### Use of the Pipette

Before beginning the laboratory sessions, point out the graduations on the pipette to the students. Both the 250  $\mu\text{l}$  and 1 milliliter marks will be used as units of measurement throughout Lessons 2 through 5.

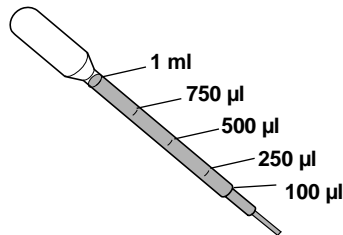

## Lesson 1 Genetic Transformation Review

### Growth Media

The liquid and solid agar media are referred to as LB (named after Luria-Bertani) broth and are made from an extract of yeast and an enzymatic digest of meat byproducts which provides a mixture of carbohydrates, amino acids, nucleotides, salts, and vitamins, all of which are nutrients for bacterial growth. Agar, which is derived from seaweed, melts when heated and cools to form a solid gel (very analogous to Jell-O), and functions to provide a solid support on which to culture bacteria.

## Antibiotic Selection

The pGLO plasmid which contains the GFP gene also contains the gene for beta-lactamase, a protein that provides bacteria with resistance to the antibiotic, ampicillin. The beta-lactamase protein is produced and secreted by bacteria which contain the plasmid. The secreted beta-lactamase inactivates ampicillin, allowing only transformed cells to grow in its presence. Only transformed bacteria which contain the pGLO plasmid, and produce beta-lactamase can survive in the presence of ampicillin. (See schematic below.)

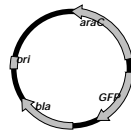
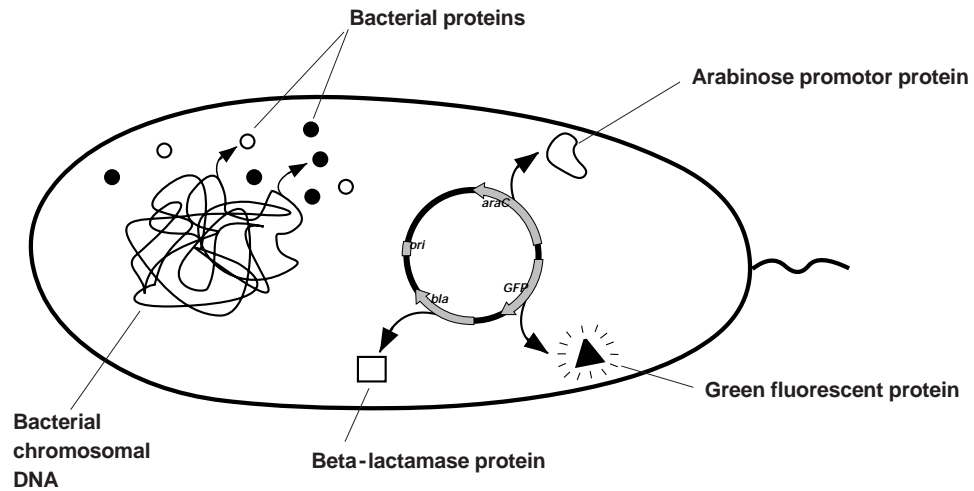

Genetically engineered plasmid used to insert new genes into bacteria.

"GFP" Gene which codes for the Green Fluorescent Protein. 

"bla" Gene which codes for beta-lactamase, a protein which gives bacteria resistance to the antibiotic, ampicillin. 

"araC" Gene which codes for AraC, a protein which regulates production of the Green Fluorescent Protein. 

## Gene Regulation

One of the main instructional highlights of the pGLO Transformation Kit was the concept of gene regulation. In this kit, the bacteria which were transformed with the pGLO plasmid were plated onto LB/amp and LB/amp/ara agar plates. Expression of the GFP gene is under the regulatory control of the arabinose promoter. Thus, when the bacteria were plated onto LB agar containing arabinose (LB/amp/ara), GFP was expressed and the colonies appeared bright green. Conversely, when the bacteria were plated onto LB agar that did not contain arabinose (LB/amp), the gene was turned off and the colonies appeared white. (See Appendix D for more details.)

The concept of gene regulation can be further expanded upon in this kit. If a white colony (which contains the GFP gene, but is not expressing GFP in the absence of arabinose) is seeded into LB/amp/ara liquid media, the arabinose present in the media will be taken up by the bacteria, which subsequently turns on the GFP gene. Thus the students will be seeding a white

colony which has the dormant GFP gene into arabinose containing media. Arabinose turns on the dormant gene, resulting in a fluorescent green liquid culture. In addition, the student will be seeding a green fluorescent colony into LB/amp/ara liquid culture. In this case the gene will remain "on" and the liquid culture will also fluoresce bright green.

## Lesson 2 Inoculation—Growing a Cell Culture

### Isolation of Single Bacterial Colonies

In this activity, students will pick one white colony from their LB/amp plates and one green colony from their LB/amp/ara plates for propagation in parallel liquid cultures.

Cloning describes the isolation and propagation of a single gene. Because a single bacterial colony originates from a single bacterium, all the individual bacteria in the colony are genetically identical and they are called clones. When the students pick colonies (or clones) of both green and white bacteria from their agar plates, single isolated colonies are chosen for transfer to the culture media. Single isolated colonies which are separated from other colonies on the agar by at least 1–2 millimeters are generally not contaminated with other bacteria. The schematic below illustrates the genes expressed in fluorescent green colonies.

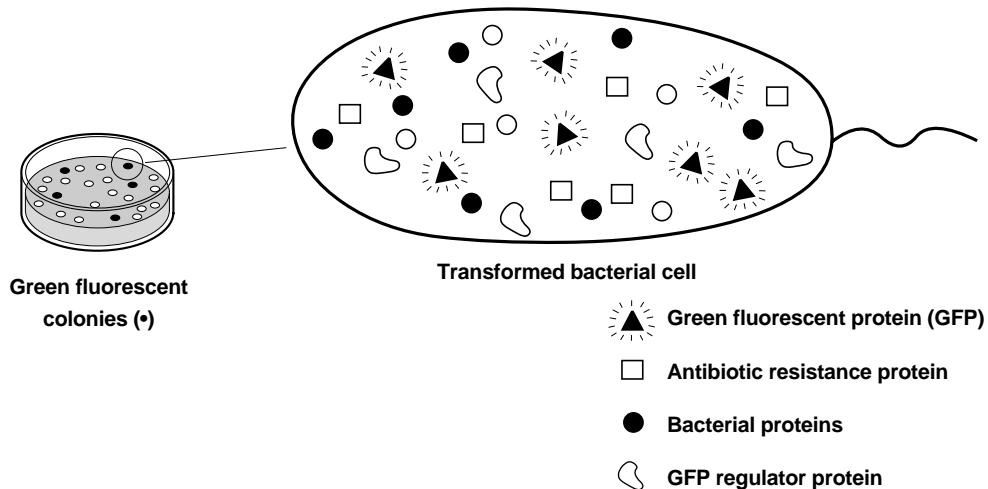

The instructor may want to demonstrate how to scoop a single, well-isolated colony from the agar using an inoculation loop. Again, it is very important that proper sterile technique is followed during the picking of colonies and subsequent dissociation of the colonies into the culture tubes. Remind students to keep their plates covered and their tubes capped wherever possible.

### Overnight Liquid Cultures

The GFP gene requires a 32 °C (or lower) incubation temperature for optimal protein folding and fluorescence. If a 32 °C incubator is unavailable, the bacteria can be cultured by shaking at room temperature, but this may require a 48 hour, rather than a 24 hour, culture period.

In this lesson, liquid bacterial cultures will yield sufficient growth and production of protein simply by incubating overnight at 32 °C. However, vigorous shaking of the liquid culture delivers more oxygen to the dividing cells allowing them to grow faster and produce more GFP. For this reason, we strongly recommend that a shaking incubator is used. If a shaking incubator is not available, cell cultures can be shaken manually for 30 seconds then incubated 1–2 days at 32 °C. Simply shake the capped culture tubes vigorously for 30 seconds—like a can of

spray paint. Then place the tubes on their sides in the incubator oven for 1–2 days. Placing the tubes horizontally in the oven maximizes the culture surface area and oxygen exchange. Removing the tubes and shaking them periodically during the incubation period will enhance cell growth further.

The more constant and more vigorous the shaking, the more growth and the more production of the Green Fluorescent Protein. In either case, following incubation, the liquid culture should fluoresce bright green upon exposure to UV light.

Culture Condition	Days Required
32 °C—shaking	1 day
32 °C—no shaking	1–2 days*
Room Temperature—shaking	2 days
Room Temperature—no shaking	Not recommended

### Lesson 3 Purification Phase 1 Bacterial Concentration and Lysis

#### Centrifugation

Centrifugation is a technique used to separate molecules on the basis of size by high speed spinning (somewhat analogous to the spin cycle in a washing machine where the clothes become compacted against the walls of the washer). In this lab session, the heavier bacterial cells will be separated from the liquid growth media by a single centrifugation step. Centrifugation results in a "**pellet**" of bacteria found at the bottom of the tube, and a liquid "**supernatant**" that resides above the pellet. The collection and concentration of bacteria is a first step in the isolation of GFP from the bacteria that were grown in the liquid media in Lesson 2.

Using a disposable pipette, students transfer the 2 milliliters of culture from the culture tube into a 2 milliliters microtube—in one gentle squirt. They will then spin the bacterial pellet down to the bottom of the microtube and pour off (discard) the liquid supernatant above the pellet. The pellet will fluoresce bright green upon exposure to UV light because the green protein is being expressed within the bacteria. At this point, this short discussion of a "pellet" and "supernatant" may be helpful.

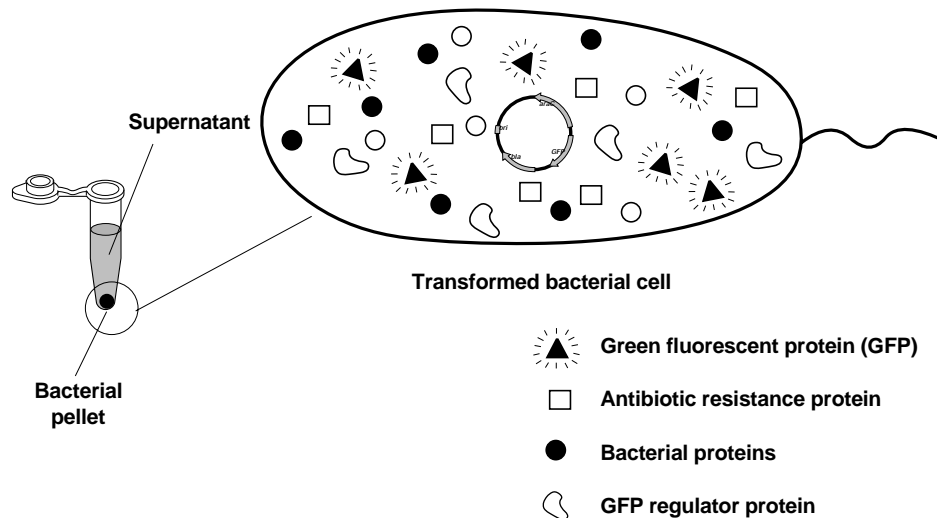

## Resuspension of the Bacterial Pellet

In this step of the protocol, it is essential that the entire bacterial pellet is resuspended in TE Buffer. The students should add 250  $\mu\text{l}$  of TE Buffer to the pellet of bacteria, and then resuspend the pellets by carefully, but rapidly, pipetting the cells up and down with the 250  $\mu\text{l}$  volume of buffer. (If vortexes are available, gentle vortexing will also aid in resuspension.) The volume in the tube can be visually inspected for large chunks of unresuspended bacteria. If chunks are observed, the students should continue to pipette up and down to fully resuspend the bacteria.

## Lysozyme

Lysozyme is an enzyme that functions to degrade (or lyse) the bacterial cell wall, by cleaving polysaccharide (sugar) residues in the cell walls. The subsequent freeze-thaw step used in this lesson aids in the complete disruption of the wall and internal membrane. Complete disruption or "lysis" releases soluble components, including GFP. Lysozyme is naturally found in human tears, acting as a bactericidal agent to help prevent bacterial eye infections. Lysozyme gets its name from its natural ability to "lyse" bacteria.

## Lesson 4 Purification Phase 2 Removing Bacterial Debris

This final centrifugation step serves to separate the large particles of lysed bacteria (such as the cell membrane and walls) from the much smaller proteins, including GFP. The larger bacterial debris are pelleted in the bottom of the microtube, while the smaller proteins remain in the supernatant. At this stage, the supernatant will fluoresce bright green upon exposure to UV light. Students should then, very carefully, remove the supernatant from the pellet and place it into a new 2.0 milliliter microtube using a clean 1 milliliter pipette. This should be done immediately to prevent pellet debris from leaching and contaminating the supernatant and potentially clogging the chromatography column in the purification procedure of lesson 5.

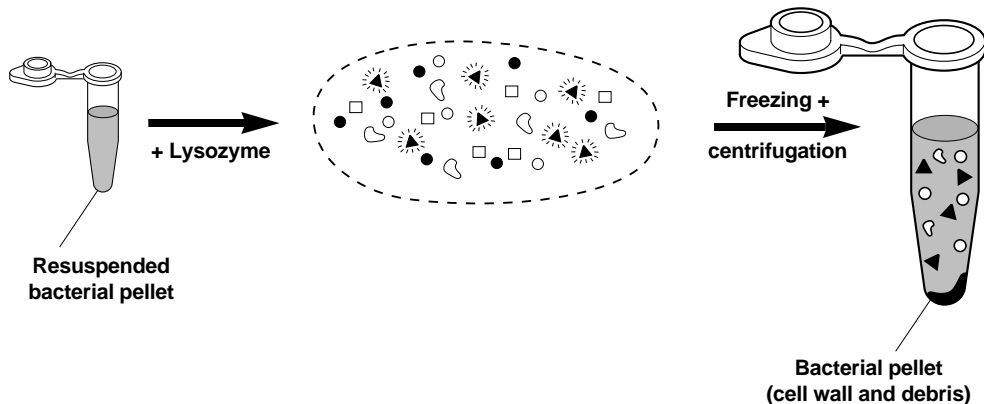

## Lesson 5 Purification Phase 3 Protein Chromatography

Chromatography is a powerful technique for separating proteins in a complex mixture. Bacteria contain thousands of endogenous proteins from which GFP must be separated. In chromatography, a cylinder, or column is densely filled with a "bed" of microscopic beads. These beads form a matrix through which proteins must pass before being collected. The matrix the students will employ in this case has an "affinity" for the molecule of interest (GFP), but not for the other bacterial proteins in the mixture. GFP "sticks" to the column, allowing it to be separated from the bacterial contaminants.



Hydrophobic ("water hating") substances do not mix well with water. When they are dropped into salty water they tend to stick together. Some of the amino acids that make up proteins are very hydrophobic. In salt water, these parts of a protein tend to stick tightly to other hydrophobic substances. High salt causes the three dimensional structure of the protein to actually change so that the hydrophobic regions of the protein are more exposed on the surface of the protein and the hydrophilic ("water-loving") regions are more shielded.

A chromatography column which is packed with hydrophobic beads is called a hydrophobic interaction matrix. When the sample is loaded onto the matrix in salt water, the hydrophobic proteins in the sample will stick to the beads in the column. The more hydrophobic they are the more tightly they will stick. When the salt is removed, the three dimensional structure of the protein changes again so that the hydrophobic regions of the protein now move to the interior of the protein and the hydrophilic ("water-loving") regions move to the exterior. The result is that the hydrophobic proteins no longer stick to the beads and drip out the bottom of the column, separated from the other proteins.

### **Hydrophobic Interaction Chromatography (HIC)**

In lessons 4 and 5, the soluble GFP in the supernatant is purified using hydrophobic interaction chromatography (HIC). GFP has several stretches of hydrophobic amino acids, which results in the total protein being very hydrophobic. When the supernatant, rich in GFP, is passed over a HIC column in a highly salty buffer (Binding Buffer), the hydrophobic regions of the GFP stick to the HIC beads. Other proteins which are less hydrophobic (or more hydrophilic) pass right through the column. This single procedure allows the purification of GFP from a complex mixture of bacterial proteins.

#### **Loading the GFP supernatant onto the chromatography column**

When students load the GFP supernatant onto their columns, it is very important that they do not disturb the upper surface of the column bed when performing the chromatography procedure. The column matrix should have a relatively flat upper surface. A slightly uneven column bed will not drastically affect the procedure. However, subsequent steps of loading, washing, and eluting should minimize disrupting the column such that beads "fluff up" into the buffer. When loading the GFP supernatant onto the column, the pipette tip should be inserted into the column and should rest against the side of the column. The supernatant should be slowly expelled from the pipette, down the walls of the column. When the supernatant has completely entered the column, a green ring of fluorescence should be visible at the top of the bed when viewed with the UV light.

There are four different buffers which are used in the HIC procedure. Each buffer should be slowly pipetted down the side of the column to minimize disturbance to the column resins.

#### **Equilibration buffer**

A medium salt buffer (2 M  $(\text{NH}_4)_2\text{SO}_4$ ) which is used to "equilibrate" or "prime" the chromatography column for the binding of GFP.

#### **Binding buffer**

An equal volume of high salt Binding Buffer (4 M  $(\text{NH}_4)_2\text{SO}_4$ ) is added to the bacterial lysate. The end result is that the supernatant containing GFP has the same salt concentration as the equilibrated column. When in a high salt solution, the hydrophobic regions of proteins are more exposed and are able to interact with and bind the hydrophobic regions of the column.

#### **Wash buffer**

A medium salt Wash Buffer (1.3 M  $(\text{NH}_4)_2\text{SO}_4$ ) is used to wash weakly associated proteins from the column; proteins which are strongly hydrophobic (GFP) remain bound to the column. When the Wash Buffer is applied to the column, care should again be taken to minimize disturbance of the column resin. Slow, steady pipetting down the side of the column is most

effective. At this point "a ring" of GFP should begin to penetrate the upper surface of the matrix (~ 1–2 mm into the bed).

### Elution buffer

A low salt buffer (TE Solution; 10 mM Tris/EDTA) is used to wash GFP from the column. In low salt buffers (which have a higher concentration of water molecules), the conformation of GFP changes so that the hydrophilic residues of GFP are more exposed to the surface, causing the GFP to have a higher affinity for the buffer than for the column, thereby allowing the GFP to wash off the column. The 0.75 milliliters of TE (Elution) Buffer is applied to the column gently, as described above. The TE Solution will disrupt the hydrophobic interactions between the GFP and the column bed, causing GFP to let go and "elute" from the column. The GFP should pass down the column as a bright green fluorescent ring. This is easily observed using the UV light. If the column bed was disturbed in any of the preceding steps, the GFP will not elute as a distinct ring, but will elute with a more irregular, distorted shape. However, elution should still occur at this step. If successful, collection tube 3 should fluoresce bright green.

### Storage of tubes

All of the collection tubes and their constituents can be parafilm or covered and stored for approximately 1–2 weeks in the refrigerator.

### Important hints for successful chromatography

1. Place the column gently into the collection tubes. Jamming the column tightly into the collection tubes will create an air tight seal and the sample will not flow through. You can create a "paper crutch" by folding a small piece of paper, about the size of a match stick, and wedging it between the column and the collection tube. This crutch makes it impossible for an air tight seal to form, and insures that the column will flow.
2. The flow rate of the column can be increased in the elution step by placing the top cap tightly back onto the column. This creates air pressure which pushes on the column bed, causing the sample to flow faster.
3. The columns are designed to drip slowly. The entire chromatography procedure should take 20 to 30 minutes. It is important not to remove the column more than needed from collection tube to collection tube, as motion can cause major disturbance to the column bed.

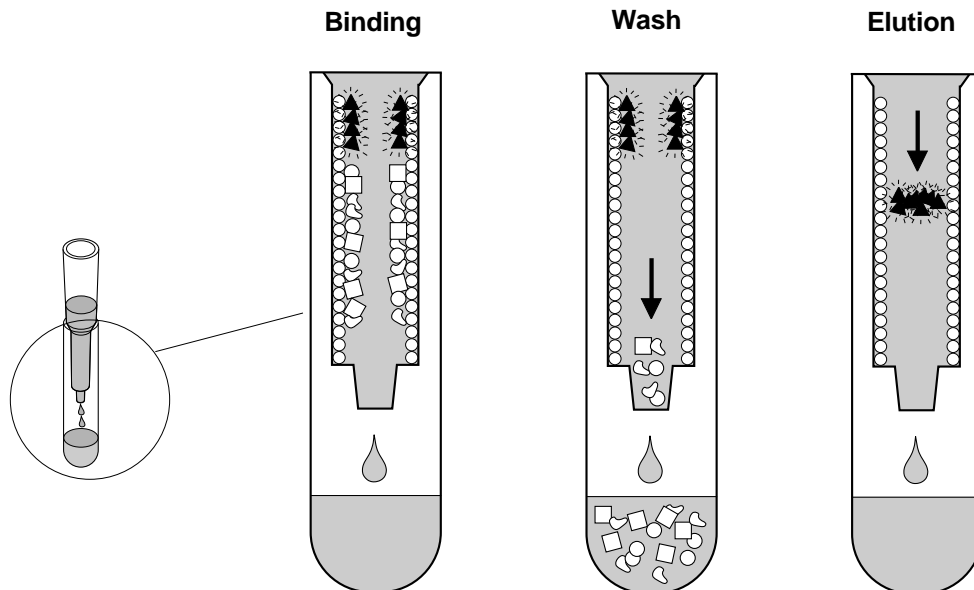

# GFP Purification—Quick Guide

## Lesson 2 Inoculation Growing Cell Cultures

1. Remove the transformation plates from the incubator and examine using the UV light. Identify several green colonies that are not touching other colonies on the LB/amp/ara plate. Identify several white colonies on the LB/amp plate.

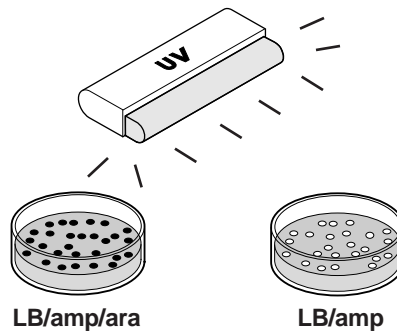

2. Obtain two culture tubes containing the growth media LB/amp/ara. Label one "+" and one "-". Using a sterile loop, lightly touch the loop to a green colony and immerse it in the "+" tube. Using a new sterile loop, repeat for a white colony and immerse it in the "-" tube (it is very important to pick only a single colony). Spin the loop between your index finger and thumb to disperse the entire colony.

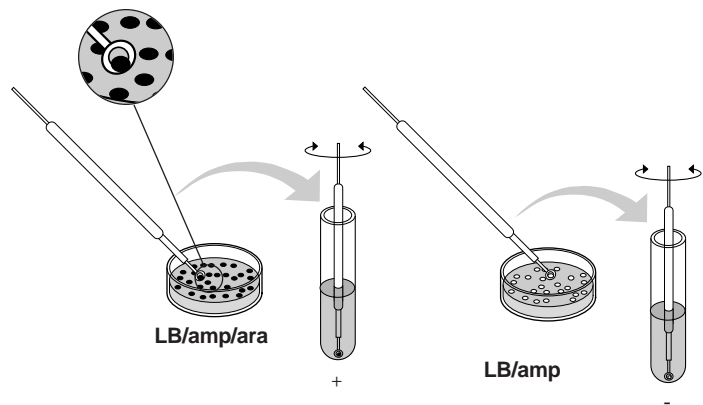

3. Cap the tubes and place them in the shaking incubator or on the shaking platform and culture overnight at 32 °C or 2 days at room temperature.

or

Cap the tubes and shake vigorously by hand. Place in the incubator horizontally at 32 °C for 24–48 hours. Remove and shake by hand periodically when possible.

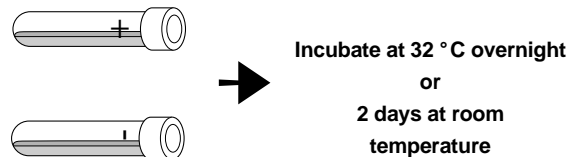

### Lesson 3 Purification Phase 1 Bacterial Concentration

1. Label one microtube "+" with your name and class period. Remove your liquid cultures from the shaker and observe with the UV light. Note any color differences between the two cultures. Using a new pipette, transfer 2 ml of "+" liquid culture into the "+" microtube. Spin the microtube for 5 minutes in the centrifuge at maximum speed. The pipette used in this step can be repeatedly rinsed in a beaker of water and used for all following steps of this laboratory period.

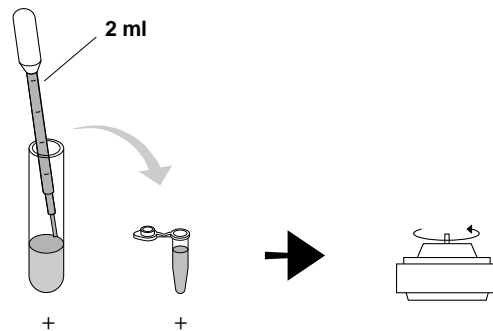

2. Pour out the supernatant and observe the pellet under UV light.



3. Using a rinsed pipette, add 250  $\mu$ l of TE solution to the tube. Resuspend the pellet thoroughly by rapidly pipetting up and down several times.

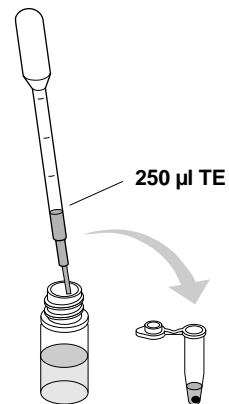

4. Using a rinsed pipette, add 1 drop of lysozyme to the resuspended bacterial pellet to initiate enzymatic digestion of the bacterial cell wall. Mix the contents gently by flicking the tube. Observe the tube under the UV light.

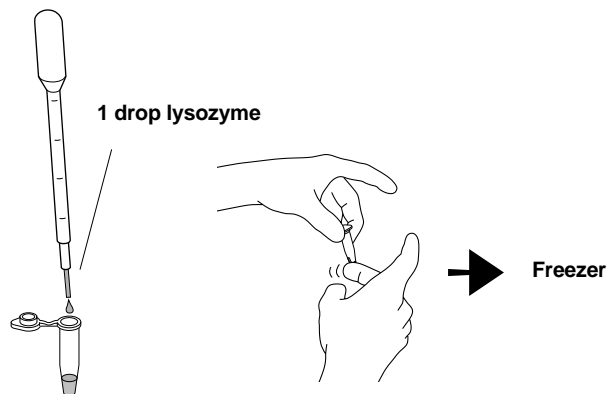

5. Place the microtube in the freezer until the next laboratory period. The freezing causes the bacteria to rupture completely.

## Lesson 4 Purification Phase 2

### Bacterial Lysis

1. Remove the microtube from the freezer and thaw using hand warmth. Place the tube in the centrifuge and pellet the insoluble bacterial debris by spinning for 10 minutes at maximum speed.

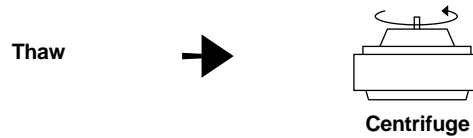

2. While your tube is spinning, prepare the chromatography column. Remove the cap and snap off the bottom from the prefilled HIC column. Allow all of the liquid buffer to drain from the column (~3–5 minutes).

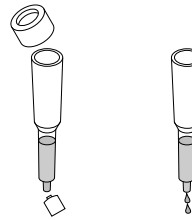

3. Prepare the column by adding 2 ml of Equilibration Buffer to the top of the column. This is done by adding two 1 ml aliquots with a rinsed pipette. Drain the buffer to the 1 ml mark on the column. Cap the top and bottom and store the column at room temperature until the next laboratory period.

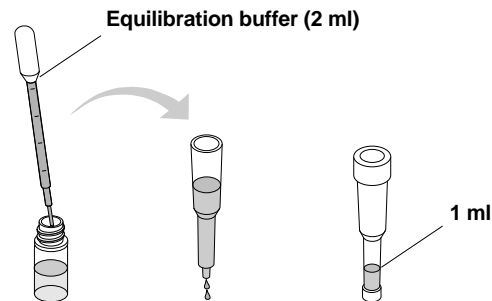

4. After the 10 minute spin, immediately remove your tube from the centrifuge. Examine the tube with the UV light. Using a new pipette, transfer 250  $\mu$ l of the "+" supernatant into a new microtube labeled "+". Again, rinse the pipette well for the rest of the steps of this lab period.

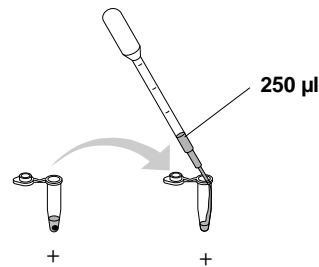

5. Using a well rinsed pipette, transfer 250  $\mu$ l of binding buffer to the "+" supernatant. Place the tube in the refrigerator until the next laboratory period.

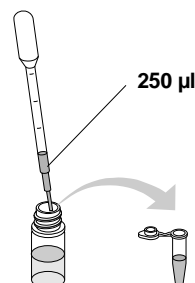

## Lesson 5 Purification Phase 3

### Protein Chromatography

1. Label 3 collection tubes 1–3 and place the tubes in the foam rack or in a rack supplied in your laboratory. Remove the caps from the top and bottom of the column and place the column in collection tube 1. When the last of the buffer has reached the surface of the HIC matrix proceed to the next step below.

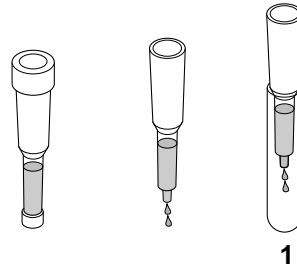

2. Using a new pipette, carefully and gently load 250  $\mu\text{l}$  of the “+” supernatant onto the top of the column. Hold the pipette tip against the side of the column wall, just above the upper surface of the matrix and let the supernatant drip down the side of the column wall. Examine the column using a UV light. Note your observations. After it stops dripping transfer the column to collection tube 2.

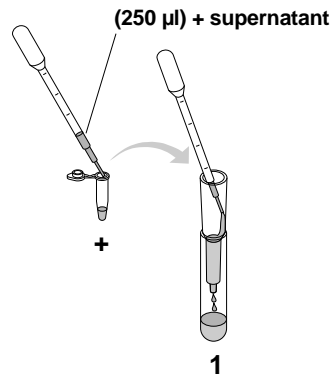

3. Using the rinsed pipette, add 250  $\mu\text{l}$  of wash buffer and let the entire volume flow into the column. Examine the column using the UV light. Note your observations. After the column stops dripping, transfer it to tube 3.

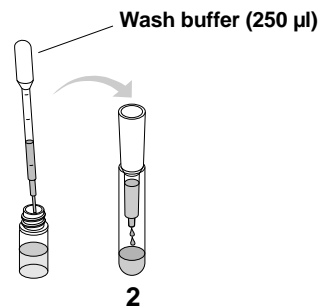

4. Using the rinsed pipette, add 750  $\mu\text{l}$  of TE Buffer and let the entire volume flow into the column. Examine the column using the UV light. Note your observations.

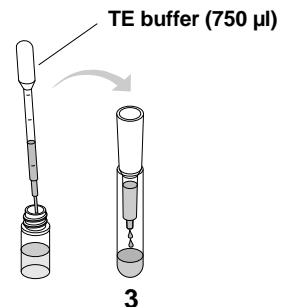

5. Examine all three collection tubes and note any differences in color between the tubes. Parafilm or Saran Wrap the tubes and place in the refrigerator until the next laboratory period.

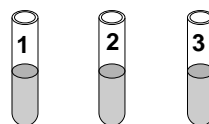

# Teachers Answer Guide

## Lesson 1 Review Questions

1. Proteins
  - a. What is a protein ?  
**A macromolecule which consists of chains of amino acids.**
  - b. List three examples of proteins found in your body.  
**Antibodies, digestive enzymes, hair proteins, hormones, and hemoglobin are all examples of proteins.**
  - c. Explain the relationship between genes and proteins.  
**Genes contain the genetic code which determine the amino acid composition of a protein. There is a unique gene for each protein within all of the cells of the body.**
2. Using your own words, define or describe cloning.  
**The duplication and propagation of a cell or organism.**
3. Describe how bacterial cells in a "library" are different from the cells of a single colony.  
**A library of bacterial cells contains a diverse mixture of bacterial types which contains a diverse mixture of genes. A single colony of bacteria originates from an individual clone which only contains a single gene.**
4. Describe how you might recover the cancer-curing protein from the bacterial cells.  
**One can isolate a single fluorescent green colony of bacteria and grow large amounts of the bacteria in a liquid growth media. Bacteria in liquid media can be concentrated by centrifugation. After the bacterial cells are lysed to release the cancer curing protein, the protein can be isolated by passage through a chromatography column which has an affinity for the cancer-curing protein.**

## Lesson 2 Review Questions

1. What is a bacterial colony?

**A bacterial colony is a large group or cluster of bacterial cells that originated from a single, clonal cell.**

2. Why did you select one green and one white bacterial colony from your agar plate(s)? What could this prove?

**A green colony was picked in order to propagate or produce large amounts of the green cancer-curing protein. A white colony was chosen as a "negative control" to show that only the green colonies contain and produce the green cancer-curing protein.**

3. How are these items helpful in this cloning experiment?

- a. ultraviolet (UV) light—**The green protein fluoresces, and is thus visible, when exposed to the UV light.**
- b. incubator—**The incubator provides a warm temperature which enables the bacteria to grow.**
- c. shaking incubator—**A shaking incubator provides a warm temperature and provides aeration which oxygenates the bacterial cultures. Increased oxygen accelerates the growth rate of bacteria.**

4. Can you predict what would happen if you took one of the green colonies from the LB/amp/ara plate and streaked it onto an LB/amp plate? Conversely, what would happen if you took a white colony from the LB/amp plate and streaked it onto an LB/amp/ara plate? Explain your answer.

**If a green colony was streaked onto an LB/amp plate, the resulting colonies would be white. This plate does not contain arabinose which is needed to induce expression of the GFP gene and generate green fluorescent colonies. If a white colony was streaked onto an LB/amp/ara plate, the resulting colonies would be green. This plate contains arabinose which induces expression of the GFP gene and generates green fluorescent colonies.**



### Lesson 3 Review Questions

1. You have used a bacterium to propagate a gene that produces a green fluorescent protein. Identify the function of these items you used in Lesson 3.
  - a. Centrifuge—**Functions to pellet the bacteria and separate the bacteria from the growth media.**
  - b. Lysozyme—**Functions to enzymatically digest the bacterial cell wall, which in turn weakens the cell wall so that it will rupture upon freezing.**
  - c. Freezer—**Functions to freeze the bacteria which causes the cytoplasm to expand, which completely ruptures the weakened cell wall.**

2. Can you explain why both liquid cultures fluoresce green?

**The green colony seeded into the (+) tube fluoresces green because the arabinose in the liquid culture media continues to induce expression of the GFP gene, which results in a green culture. The white colony seeded into the (-) tube fluoresces green because the arabinose in the liquid culture media turns on expression of the GFP gene which was previously off on the LB/amp plate (which lacks arabinose), which results in a green culture.**

3. Why did you discard the supernatant in this part of the protein purification procedure?

**The supernatant contains the bacterial growth media and does not contain the desired GFP.**

4. Why did you discard the white liquid from the "-" tube but keep the green one?

**The white culture of bacteria does not contain the GFP and is not needed for the subsequent purification step.**

5. Can you explain why the bacterial cells' outer cell wall ruptures when the cells are frozen? What happens to an unopened soft drink when it freezes?

**When a bacterial cell freezes, the volume of cytoplasm expands. The expansion puts pressure on the weakened cell wall, which then ruptures from the pressure.**

6. What was the purpose of rupturing or lysing the bacteria?

**The bacteria need to be ruptured in order to release the GFP, which can then be purified using column chromatography.**

## Lesson 4 Review Questions

1. What color was the pellet in this step of the experiment? What color was the supernatant? What does this tell you?

**The pellet should be a whitish or pale green color. The supernatant should fluoresce bright green. The fluorescent green color of the supernatant indicates that the green protein was released from the bacteria and remained in the supernatant. The much lighter color of the bacterial pellet suggests that the GFP was released from the bacteria upon lysis.**

2. Why did you discard the pellet in this part of the protein purification procedure?

**The pellet contains unwanted bacterial debris—bacterial cell walls, membranes, and chromosomal DNA. The pellet contains little, if any, GFP and can be discarded.**

3. Briefly describe hydrophobic interaction chromatography and identify its purpose in this lab.

**Protein chromatography is a technique which can be used to separate or purify proteins from other molecules. This lab used hydrophobic interaction chromatography to purify GFP based upon its hydrophobic properties.**

## Lesson 5 Review Questions

- List your predictions and observations for the sample and what happens to the sample when the following buffers are added to the HIC column.

Collection Tube Number	Prediction	Observations Under UV Light (column and collection tube)
<b>Tube 1</b> Sample in Binding Buffer	<b>GFP should stick to the column</b>	<b>GFP resides as a band at the top of the column</b>
<b>Tube 2</b> Sample in Wash Buffer	<b>GFP should stick to the column</b>	<b>GFP remains as a broad band on top of the column</b>
<b>Tube 3</b> Sample with Elution Buffer	<b>GFP should elute from the column</b>	<b>GFP travels down the column as a ring and elutes into tube 3</b>

- Using the data table above, compare how your predictions matched up with your observations for each buffer.
  - Binding Buffer—**GFP binds to the top of the chromatography column.**
  - Wash Buffer—**GFP remained bound to the top of the column.**
  - Elution Buffer—**GFP is eluted from the column.**
- Based on your results, explain the roles or functions of these buffers. Hint: how does the name of the buffer relate to its function?
  - Equilibration Buffer—**This buffer prepares the column for the application of GFP. Equilibration buffer raises the salt concentration of the column to match that of the bacterial GFP lysate.**
  - Binding Buffer—**This buffer raises the salt concentration of GFP which causes a conformational change in GFP, exposing the hydrophobic regions.**
  - Wash Buffer—**Wash buffer functions to wash away less hydrophobic, contaminating proteins from the column.**
  - TE (elution) Buffer—**This buffer functions to remove GFP from the column.**
- Which buffers have the highest salt content and which have the least? How can you tell?

**Binding Buffer >>Equilibration buffer>>Wash buffer>>Elution buffer**

**Binding buffer has the highest concentration of salt because it is needed to raise the salt concentration of the GFP lysate. The hydrophobic patches of proteins are exposed in high salt buffer. TE elution buffer has the lowest salt concentration because it causes GFP to elute from the column. The hydrophobic patches of proteins re-orient to the interior, and the hydrophilic regions are exposed in low salt buffer.**

5. Were you successful in isolating and purifying GFP from the cloned bacterial cells? Identify the evidence you have to support your answer.

**If tube 3 fluoresces green, the student was successful in purifying GFP. If GFP is not present in tube 3, examine the column—application of an incorrect buffer would prevent the elution. Alternatively, if the student did not start with a bright green culture, then tube 3 will not be extremely bright.**

# Green Fluorescent Protein (GFP) Purification

## Student Manual

*"Bioengineered DNA was, weight for weight, the most valuable material in the world. A single microscopic bacterium, too small to see with the human eye, but containing the gene for a heart attack enzyme, streptokinase, or for "ice-minus" which prevented frost damage to crops, might be worth 5 billion dollars to the right buyer."*

*Michael Crichton - Jurassic Park*

### **Contents**

- Lesson 1** Genetic Transformation Review—Finding the Green Fluorescent Molecule
- Lesson 2** Inoculation—Growing a Cell Culture
- Lesson 3** Purification Phase 1—Bacterial Concentration and Lysis
- Lesson 4** Purification Phase 2—Removing Bacterial Debris
- Lesson 5** Purification Phase 3—Protein Chromatography

## Lesson 1 Finding the Green Fluorescent Molecule

### Genetic Transformation Review

In Bio-Rad Kit 1, you performed a genetic transformation of *E. coli* bacterial cells. The results of this procedure were colonies of cells that fluoresced when exposed to ultraviolet light. This is not a normal phenotype (characteristic) for *E. coli*. You were then asked to figure out a way to determine which molecule was becoming fluorescent under UV light. After determining that the pGLO plasmid DNA was not responsible for the fluorescence under the UV light, you concluded that it was not the plasmid DNA that was fluorescing in response to the ultraviolet light within the cells. This then led to the next hypothesis that if it is not the DNA fluorescing when exposed to the UV light, then it must be a protein that the new DNA produces within the cells.

1. Proteins.
  - a. What is a protein?
  
  - b. List three examples of proteins found in your body.
  
  - c. Explain the relationship between genes and proteins.
  
2. Using your own words, describe cloning.
  
  
  
  
  
  
  
  
  
  
3. Describe how the bacterial cloned cells on your LB/amp plate differ from the cells on your LB/amp/ara plate. Can you design an experiment to show that both plates of cloned cells behave similarly and do contain the same DNA?
  
  
  
  
  
  
  
  
  
  
4. Describe how you might recover the cancer-curing protein from the bacterial cells.

## Laboratory Procedure for Lesson 2

### Picking Colonies and Growing a Cell Culture

Examine your two transformation plates under the ultraviolet (UV) lamp. On the LB/amp plate pick out a single colony of bacteria that is well separated from all the other colonies on the plate. Use a magic marker to circle it on the bottom of the plate. Do the same for a single green colony on the LB/amp/ara plate. Theoretically both white and green colonies were transformed with the pGLO plasmid? How can you tell?

Both colonies should contain the gene for the Green Fluorescent Protein. To find out, you will place each of the two different bacterial colonies (clones) into two different culture tubes and let them grow and multiply overnight.

### Your Task

In this lab, you will pick one white colony from your LB/amp plate and one green colony from your LB/amp/ara plate for propagation in separate liquid cultures. Since it is hypothesized that the cells contain the Green Fluorescent Protein, and it is this protein we want to produce and purify, your first consideration might involve thinking of how to produce a large number of cells that produce GFP.

You will be provided with two tubes of liquid nutrient broth into which you will place cloned cells that have been transformed with the pGLO plasmid.

### Workstation Daily Inventory Check (✓) List

**Your Workstation.** Materials and supplies that should be present at your student workstation site prior to beginning this lab activity are listed below.

**Instructors (Common) Workstation.** Materials, supplies, and equipment that should be present at a common location that can be accessed by your group during each lab activity are also listed below.

<b>Your workstation</b>	<b>Number</b>	<b>(✓)</b>
Transformation plates from Kit 1 (LB/amp/ara and LB/amp)	2	<input type="checkbox"/>
Inoculation loops	2	<input type="checkbox"/>
Culture tubes, containing 2 ml growth media	2	<input type="checkbox"/>
Marking pen	1	<input type="checkbox"/>
Test tube holder	1	<input type="checkbox"/>
<b>Instructors workstation</b>		
Shaking incubator or platform (optional)	1	<input type="checkbox"/>
UV light	1	<input type="checkbox"/>

## Laboratory Procedure for Lesson 2

1. Examine your LB/amp and LB/amp/ara plates from the transformation lab. First use normal room lighting, then use an ultraviolet light in a darkened area of your laboratory. Note your observations.

To prevent damage to your skin or eyes, avoid exposure to the UV light. Never look directly into the UV lamp. Wear safety glasses whenever possible.

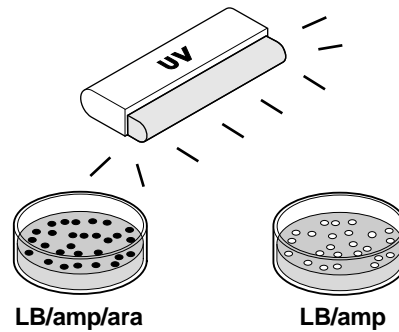

2. Identify several green colonies that are not touching other colonies on the LB/amp/ara plate. Turn the plate over and circle several of these green colonies. On the other LB/amp plate identify and circle several white colonies that are also well isolated from other colonies on the plate.
3. Obtain two 15 milliliter culture tubes containing 2 milliliters of nutrient growth media and label one tube "+" and one tube "-". Using a sterile inoculation loop, lightly touch the "loop" end to a circled single green colony and scoop up the cells without grabbing big chunks of agar. Immerse the loop in the "+" tube. Spin the loop between your index finger and thumb to disperse the entire colony. Using a new sterile loop, repeat for a single white colony and immerse it in the "-" tube. It is very important to pick cells from a single bacterial colony.

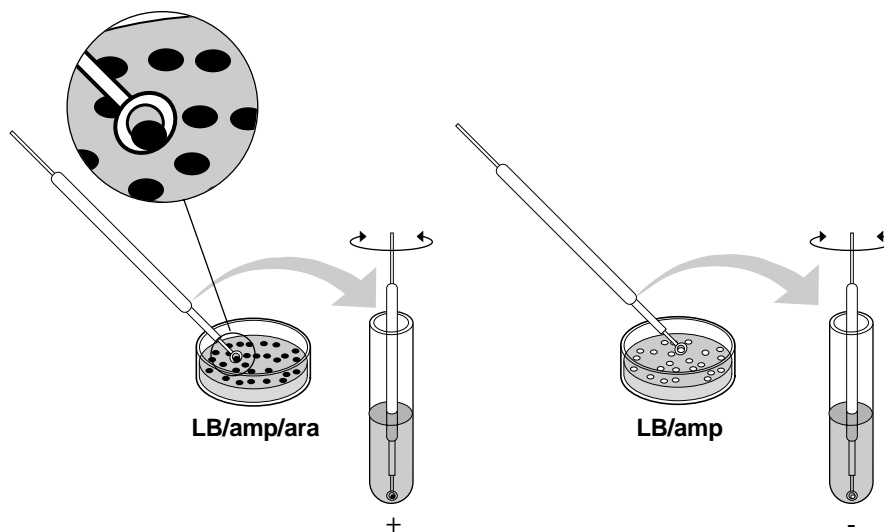



4. Cap your tubes and place them in the shaker or incubator. Let the tubes incubate for 24 hours at 32 °C or for 2 days at room temperature. If a shaker is not available, shake your two tubes vigorously, like you would shake a can of spray paint, for about 30 seconds. Then place them in an incubator oven for 24 hours. Lay the tubes down horizontally in the incubator. (If a rocking table is available, but no incubator, tape the tubes to the platform and let them rock at maximum speed for 24 hours at 32° or at room temperature for 48 hours. We do not recommend room temperature incubation without rocking or shaking.)

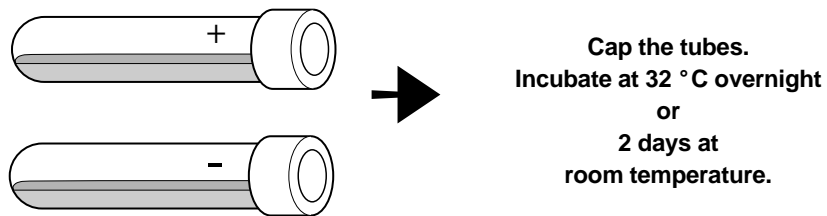

<b>Culture Condition</b>	<b>Days Required</b>
32 °C—shaking	1 day
32 °C—no shaking	1–2 days*
Room Temperature—shaking	2 days
Room Temperature—no shaking	Not recommended

\* Periodically shake by hand and lay tubes horizontally in incubator.



## Lesson 3

### Purification Phase 1

#### Bacterial Concentration and Lysis

So far you have mass produced living cultures of two cloned bacterium. Both contain the gene which produces the green fluorescent protein. Now it is time to extract the green protein from its bacterial host. Since it is the bacterial cells that contain the green protein, we first need to think about how to collect a large number of these bacterial cells.

A good way to concentrate a large number of cells is to place a tube containing the liquid cell culture into a centrifuge and spin it. As you spin the cell culture, where would you expect the cells to concentrate, in the liquid portion or at the bottom of the tube in a pellet?

#### Workstations Check (✓) List

**Your Workstation.** Make sure the correct materials listed below are present at your workstation prior to beginning this lab experiment.

**Instructors (Common) Workstation.** Materials that should be present at a common location to be accessed by your group are also listed below.

<b>Your workstation</b>	<b>Number</b>	<b>(✓)</b>
Microtubes	1	<input type="checkbox"/>
Pipette	1	<input type="checkbox"/>
Microtube rack	1	<input type="checkbox"/>
Marker	1	<input type="checkbox"/>
Beaker of water for rinsing pipettes	1	<input type="checkbox"/>

#### Instructors workstation

TE solution	1 vial	<input type="checkbox"/>
Lysozyme (rehydrated)	1 vial	<input type="checkbox"/>
Centrifuge	1	<input type="checkbox"/>
UV light	1-4	<input type="checkbox"/>

### Laboratory Procedure for Lesson 3

1. Using a marker, label one new microtube with your name and period.
2. Remove your two liquid cultures from the shaker or incubator and observe them in normal room lighting and then with the UV light. Note any color differences that you observe. Using a clean pipette, transfer the entire contents of the (+) liquid culture into the 2 milliliter microtube also labeled (+), then cap it. You may now set aside your (-) culture for disposal.

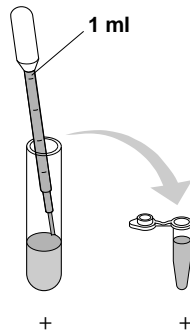

3. Spin the (+) microtube for 5 minutes in the centrifuge at maximum speed. Be sure to balance the tubes in the machine. If you do not know how to balance the tubes, do not operate the centrifuge.
4. After the bacterial liquid culture has been centrifuged, open the tube and slowly pour off the liquid supernatant above the pellet. After the supernatant has been discarded, there should be a large bacterial pellet remaining in the tube.

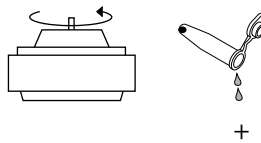

5. Observe the pellet under UV light. Note your observations.
6. Using a new pipette, add 250  $\mu$ l of TE Solution to each tube. Resuspend the bacterial pellet thoroughly by rapidly pipetting up and down several times with the pipette.

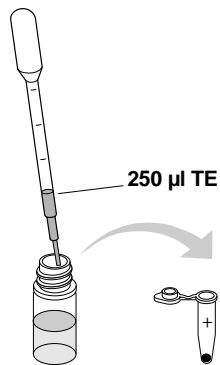

- Using a rinsed pipette, add 1 drop of lysozyme to the resuspended bacterial pellet. Cap and mix the contents by flicking the tube with your index finger. The lysozyme will start digesting the bacterial cell wall. Observe the tube under the UV light. Place the microtube in the freezer until the next laboratory period. The freezing will cause the bacteria to explode and rupture completely.

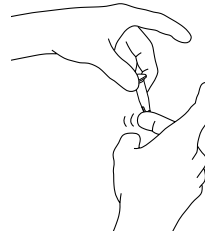
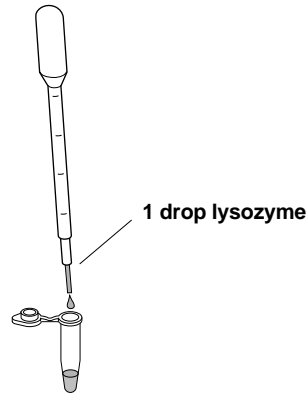

## Lesson 3

Name \_\_\_\_\_

### Review Questions

1. You have used a bacterium to propagate a gene that produces a green fluorescent protein. Identify the function of these items you need in Lesson 3.
  - a. Centrifuge -
  - b. Lysozyme -
  - c. Freezer -
  
2. Can you explain why both liquid cultures fluoresce green?
  
  
  
  
  
  
  
  
  
  
3. Why did you discard the supernatant in this part of the protein purification procedure?
  
  
  
  
  
  
  
  
  
  
4. Can you explain why the bacterial cells' outer membrane ruptures when the cells are frozen. What happens to an unopened soft drink when it freezes?
  
  
  
  
  
  
  
  
  
  
5. What was the purpose of rupturing or lysing the bacteria?

## Lesson 4

### Purification Phase 2

#### Bacterial Lysis

The bacterial lysate that you generated in the last lab contains a mixture of GFP and endogenous bacterial proteins. Your goal is to separate and purify GFP from these other contaminating bacterial proteins. Proteins are long chains of amino acids, some of which are very hydrophobic or "water-hating". GFP has many patches of hydrophobic amino acids, which collectively make the entire protein hydrophobic. Moreover, GFP is much more hydrophobic than most of the other bacterial proteins. We can take advantage of the hydrophobic properties of GFP to purify it from the other, less hydrophobic (more hydrophilic or "water-loving") bacterial proteins.

Chromatography is a powerful method for separating proteins and other molecules in complex mixtures and is commonly used in biotechnology to purify genetically engineered proteins. In chromatography, a column is filled with microscopic spherical beads. A mixture of proteins in a solution passes through the column by moving downward through the spaces between the beads.

You will be using a column filled with beads that have been made very hydrophobic—the exact technique is called hydrophobic interaction chromatography (HIC). When the lysate is applied to the column, the hydrophobic proteins that are applied to the column in a high salt buffer will stick to the beads while all other proteins in the mixture will pass through. When the salt is decreased, the hydrophobic proteins will no longer stick to the beads and will drip out the bottom of the column in a purified form.

#### Workstations Check (✓) List

**Student Workstations.** Make sure the materials listed below are present at your workstation prior to beginning this lab experiment.

**Instructors (Common) Workstation.** Materials that should be present at a common location to be accessed by your group are also listed below.

<b>Student workstation items</b>	<b>Number</b>	<b>(✓)</b>
Microtubes	1	<input type="checkbox"/>
Pipette	1	<input type="checkbox"/>
Microtube rack	1	<input type="checkbox"/>
Marker	1	<input type="checkbox"/>
Beaker of water for rinsing pipettes	1	<input type="checkbox"/>
HIC chromatography column	1	<input type="checkbox"/>
Column end cap	1	<input type="checkbox"/>
Waste beaker or tube	1	<input type="checkbox"/>
<b>Instructors workstation items</b>		
Binding Buffer	1 vial	<input type="checkbox"/>
Equilibration Buffer	1 vial	<input type="checkbox"/>
Centrifuge	1	<input type="checkbox"/>
UV light	1–4	<input type="checkbox"/>

## Laboratory Procedure for Lesson 4

1. Remove your microtube from the freezer and thaw it out using hand warmth. Place the tube in the centrifuge and pellet the insoluble bacterial debris by spinning for 10 minutes at maximum speed. Label a new microtube with your team's initials.
2. While you are waiting for the centrifuge, prepare the chromatography column. Before performing the chromatography, shake the column vigorously to resuspend the beads. Then shake the column down one final time, like a thermometer, to bring the beads to the bottom. Tapping the column on the table-top will also help settle the beads at the bottom. Remove the top cap and snap off the tab bottom of the chromatography column. Allow all of the liquid buffer to drain from the column (this will take ~3–5 minutes).



3. Prepare the column by adding 2 milliliters of Equilibration Buffer to the top of the column, 1 milliliter at a time using a well rinsed pipette. Drain the buffer from the column until it reaches the 1 milliliter mark which is just above the top of the white column bed. Cap the top and bottom of the column and store the column at room temperature until the next laboratory period.

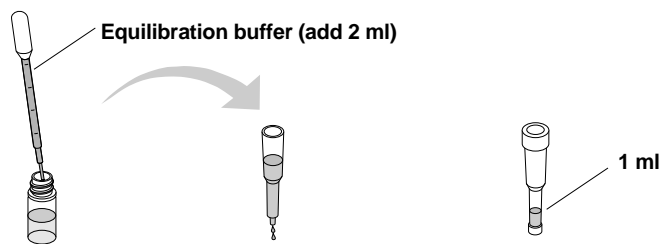

4. After the 10 minute centrifugation, immediately remove the microtube from the centrifuge. Examine the tube with the UV light. The bacterial debris should be visible as a pellet at the bottom of the tube. The liquid that is present above the pellet is called the supernatant. Note the color of the pellet and the supernatant. Using a new pipette, transfer 250  $\mu$ l of the supernatant into the new microtube. Again, rinse the pipette well for the rest of the steps of this lab period.

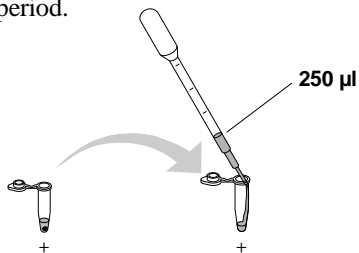

5. Using the well-rinsed pipette, transfer 250  $\mu$ l of Binding Buffer to the microtube containing the supernatant. Place the tube in the refrigerator until the next laboratory period.

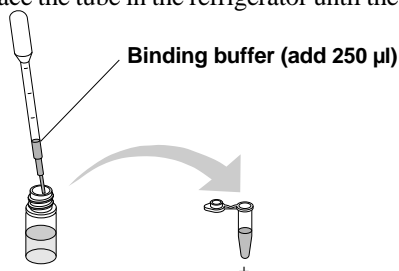





## Lesson 5

### Purification Phase 3 Protein Chromatography

In this final step of purifying the Green Fluorescent Protein, the bacterial lysate you prepared will be loaded onto a hydrophobic interaction column (HIC). Remember that GFP contains an abundance of hydrophobic amino acids making this protein much more hydrophobic than most other bacterial proteins. In the first step, you will pass the supernatant containing the bacterial proteins and GFP over an HIC column in a highly salty buffer. The salt causes the three-dimensional structure of proteins to actually change so that the hydrophobic regions of the protein move to the exterior of the protein and the hydrophilic ("water-loving") regions move to the interior of the protein.

The chromatography column at your workstation contains a matrix of microscopic hydrophobic beads. When your sample is loaded onto this matrix in very salty buffer, the hydrophobic proteins should stick to the beads. The more hydrophobic the proteins, the tighter they will stick. The more hydrophilic the proteins, the less they will stick. As the salt concentration is decreased, the three-dimensional structure of proteins change again so that the hydrophobic regions of the proteins move back into the interior and the hydrophilic ("water-loving") regions move to the exterior.

You will use these four solutions to complete the chromatography:

**Equilibration Buffer**—A high salt buffer (2 M  $(\text{NH}_4)_2\text{SO}_4$ )

**Binding Buffer**—A very high salt buffer (4 M  $(\text{NH}_4)_2\text{SO}_4$ )

**Wash Buffer**—A medium salt buffer (1.3 M  $(\text{NH}_4)_2\text{SO}_4$ )

**Elution Buffer**—A very low salt buffer (10 mM Tris/EDTA)

#### Workstation Check (✓) List

**Your Workstation.** Make sure the materials listed below are present at your workstation prior to beginning this lab experiment.

**Instructors (Common) Workstation.** Materials that should be present at a common location to be accessed by your group are also listed below.

<b>Your workstation</b>	<b>Number</b>	<b>(✓)</b>
Collection tubes	3	<input type="checkbox"/>
Pipette	1	<input type="checkbox"/>
Microtube rack	1	<input type="checkbox"/>
Marker	1	<input type="checkbox"/>
Beaker of water for rinsing pipettes	1	<input type="checkbox"/>
HIC chromatography column	1	<input type="checkbox"/>
Column end cap	1	<input type="checkbox"/>
Test tube or beaker to collect waste	1	<input type="checkbox"/>
<b>Instructors workstation</b>		
Wash Buffer	1 vial	<input type="checkbox"/>
Equilibration Buffer	1 vial	<input type="checkbox"/>
TE Buffer	1 vial	<input type="checkbox"/>
UV light	1–4	<input type="checkbox"/>

## Lesson 5 Laboratory Procedure

1. Obtain 3 collection tubes and label them 1, 2, and 3. Place the tubes in a rack. Remove the cap from the top and bottom of the column and let it drain completely into a liquid waste container (an extra test tube will work well). When the last of the buffer has reached the surface of the HIC column bed, gently place the column on collection tube 1. Do not force the column tightly into the collection tubes—the column will not drip.

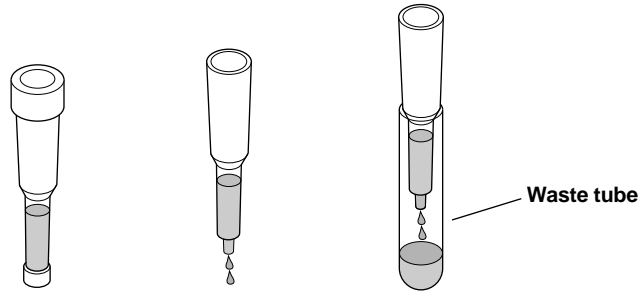

2. Predict what you think will happen for the following steps and write it along with your actual observations in the data table on page 42.
3. Using a new pipette, carefully load 250  $\mu\text{l}$  of the supernatant (in Binding Buffer) into the top of the column by resting the pipette tip against the side of the column and letting the supernatant drip down the side of the column wall. Examine the column using the UV light. Note your observations in the data table. Let the entire volume of supernatant flow into tube 1.

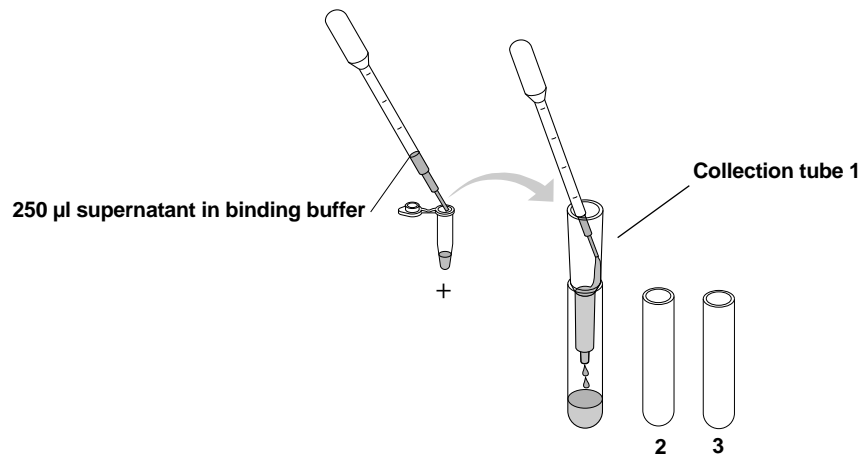

4. Transfer the column to collection tube 2. Using the rinsed pipette and the same loading technique described above, add 250  $\mu$ l of Wash Buffer and let the entire volume flow into the column. As you wait, predict the results you might see with this buffer. Examine the column using the UV light and list your results on page 42.

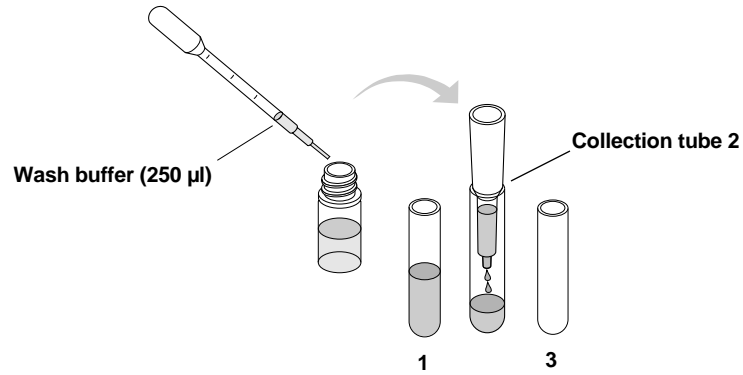

5. Transfer the column to tube 3. Using the rinsed pipette, add 750  $\mu$ l of TE buffer (Elution Buffer) and let the entire volume flow into the column. Again, make a prediction and then examine the column using the UV light. List the results in the data table on page 42.

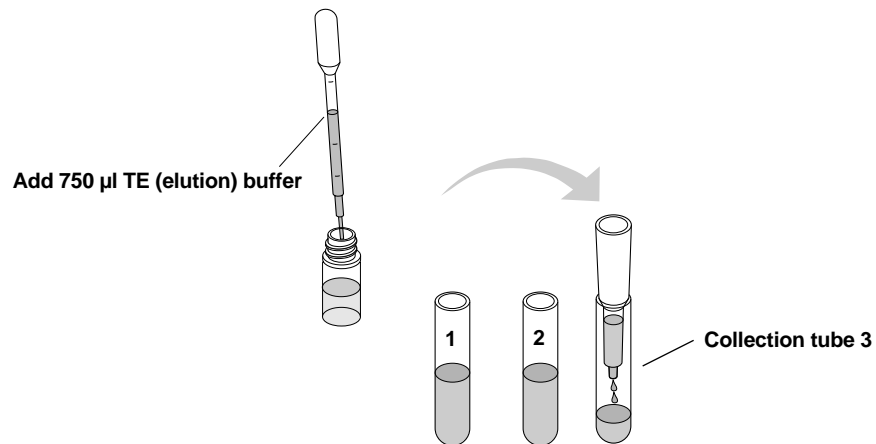

6. Examine all of the collection tubes using the UV lamp and note any differences in color between the tubes. Parafilm or Saran Wrap the tubes and place in the refrigerator until the next laboratory period.

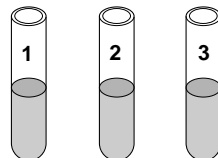

## Lesson 5

Name \_\_\_\_\_

### Review Questions

1. List your predictions and observations for the sample and what happens to the sample when the following buffers are added to the HIC column.

<b>Collection Tube Number</b>	<b>Prediction</b>	<b>Observations Under UV Light</b> (column and collection tube)
<b>Tube 1</b> Sample in Binding Buffer		
<b>Tube 2</b> Sample with Wash Buffer		
<b>Tube 3</b> Sample with Elution Buffer		

2. Using the data table above, compare how your predictions matched up with your observations for each buffer.
  - a. Binding Buffer-
  - b. Wash Buffer-
  - c. Elution Buffer-
3. Based on your results, explain the roles or functions of these buffers. Hint: how does the name of the buffer relate to its function.
  - a. Equilibration Buffer-
  - b. Binding Buffer-
  - c. Wash Buffer-
  - d. TE (Elution) Buffer-
4. Which buffers have the highest salt content and which have the least? How can you tell?
5. Were you successful in isolating and purifying GFP from the cloned bacterial cells? Identify the evidence you have to support your answer.

## Appendix A Glossary of Terms

<b>Agar</b>	Provides a solid matrix to support bacterial growth. Contains nutrient mixture of carbohydrates, amino acids, nucleotides, salts, and vitamins.
<b>Antibiotic Selection</b>	The plasmid used to move the genes into the bacteria also contain the gene for beta-lactamase which provides resistance to the antibiotic ampicillin. The beta-lactamase protein is produced and secreted by bacteria which contain the plasmid. The secreted beta-lactamase inactivates the ampicillin present in the LB/agar, which allows for bacterial growth. Only bacteria which contain the plasmids, and express beta-lactamase can survive on the plates which contain ampicillin. Only a very small percentage of the cells take up the plasmid DNA and are transformed. Non-transformed cells, cells that do not contain the plasmid, can not grow on the ampicillin selection plates.
<b>Arabinose</b>	A carbohydrate, normally used as source of food by bacteria.
<b>Bacterial Library</b>	A collection of <i>E. coli</i> that has been transformed with recombinant plasmid vectors carrying DNA inserts from a single species.
<b>Bacterial Lysate</b>	Material released from inside a lysed bacterial cell. Includes proteins, nucleic acids, and all other internal cytoplasmic constituents.
<b>Beta-Lactamase</b>	Beta-lactamase is a protein which provides resistance to the antibiotic ampicillin. The beta-lactamase protein is produced and secreted by bacteria which have been transformed with a plasmid containing the gene for beta-lactamase ( <i>bla</i> ). The secreted beta-lactamase inactivates the ampicillin present in the growth medium, which allows for bacterial growth and expression of newly acquired genes also contained on the plasmid <i>i.e.</i> GFP.
<b>Biotechnology</b>	Applying biology in the real world by the specific manipulation of living organisms, especially at the genetic level, to produce potentially beneficial products.
<b>Chromatography</b>	A process for separating complex liquid mixtures of proteins or other molecules by passing a liquid mixture over a column containing a solid matrix. The properties of the matrix can be tailored to allow for the selective separation of one kind of molecule from another. Properties include solubility, molecular size, and charge.

<b>Cloning</b>	When a population of cells is prepared by growth from a single cell, all the cells in the population will be genetically identical. Such a population is called “clonal”. The process of creating a clonal population is called “cloning”. Identical copies of a specific DNA sequence, or gene, can be accomplished following mitotic division of a transformed host cell.
<b>Colony</b>	A clump of genetically identical bacterial cells growing on an agar plate. Because all the cells in a single colony are genetically identical, they are called clones.
<b>Centrifugation</b>	Spinning a mixture at very high speed to separate heavy and light particles. In this case, centrifugation results in a “pellet” found at the bottom of the tube, and a liquid “supernatant” that resides above the pellet.
<b>Culture Media</b>	The liquid and solid media are referred to as LB (named after Luria-Bertani) broth and agar are made from an extract of yeast and an enzymatic digest of meat byproducts which provides a mixture of carbohydrates, amino acids, nucleotides, salts, and vitamins, all of which are nutrients for bacterial growth. Agar, which is from seaweed, polymerizes when heated to form a solid gel (very analogous to Jell-O), and functions to provide a solid support on which to culture the bacteria.
<b>DNA Library</b>	<p>When DNA is extracted from a given cell type, it can be cut into pieces and the pieces can be cloned en masse into a population of plasmids. This process produces a population of hybrid <i>i.e.</i> recombinant DNAs. After introducing these hybrids back into cells, each transformed cell will have received and propagated one unique hybrid. Every hybrid will contain the same vector DNA but a different “insert” DNA.</p> <p>If there are 1,000 different DNA molecules in the original mixture, 1,000 different hybrids will be formed; 1,000 different transformant cells will be recovered, each carrying one of the original 1,000 pieces of genetic information. Such a collection is called a DNA library. If the original extract came from human cells, the library is a human library.</p> <p>Individual DNAs of interest can be fished out of such a library by screening the library with an appropriate probe.</p>
<b>Genetic Engineering</b>	The manipulation of an organism’s genetic material (DNA) by introducing or eliminating specific genes.

<b>Gene Regulation</b>	Gene expression in all organisms is carefully regulated to allow for differing conditions and to prevent wasteful overproduction of unneeded proteins. The genes involved in the transport and breakdown of food are good examples of highly regulated genes. For example, the simple sugar, arabinose, can be used as a source of energy and carbon by bacteria. The bacterial enzymes that are needed to breakdown or digest arabinose for food are not expressed in the absence of arabinose but are expressed when arabinose is present in the environment. In other words when arabinose is around the genes for these digestive enzymes are turned on. When arabinose runs out these genes are turned back off. See Appendix D for a more detailed explanation of the role that arabinose plays in the regulation and expression of the green fluorescent protein gene.
<b>Green Fluorescent Protein</b>	Green Fluorescent Protein (GFP) was originally isolated from the bioluminescent jellyfish, <i>Aequorea victoria</i> . The gene for GFP has recently been cloned. The unique three-dimensional conformation of GFP causes it to resonate when exposed to ultraviolet and give off energy in the form of visible green light.
<b>Lysozyme</b>	Enzyme needed to lyse, or break open bacteria cell walls. The enzyme occurs naturally in human tears, acting as a bactericidal agent to help prevent bacterial eye infections. Lysozyme gets its name from its ability to lyse bacteria.
<b>Pellet</b>	In centrifugation, the heavier particles such as bacteria or the cellular membranes and other debris of lysed bacteria are found at the bottom of a microfuge tube in a pellet.
<b>Plasmid</b>	A circular DNA molecule, capable of autonomous replication, carrying one or more genes for antibiotic resistance proteins.
<b>pGLO</b>	Plasmid containing the GFP sequence and ampicillin resistance gene which codes for Beta-lactamase.
<b>Recombinant DNA Technology</b>	The process of cutting and recombining DNA fragments as a means to isolate genes or to alter their structure and function.
<b>Screening</b>	Process of identifying wanted bacteria from a bacterial library.
<b>Sterile Technique</b>	Minimizing the possibility of outside bacterial contamination during an experiment through observance of cleanliness and using careful laboratory techniques. See Appendix C.
<b>Streaking</b>	Process of passing an inoculating loop with bacteria on it across an agar plate.



**Supernatant**

Liquid containing cellular debris that are lighter than the debris in the pellet formed after centrifugation.

**Vector**

An autonomously replicating DNA molecule into which foreign DNA fragments are inserted and then propagated in a host cell (*i.e.* plasmid).

## Appendix B

### Basic Molecular Biology Concepts and Terminology

A study of the living world reveals that all living organisms organize themselves in some unique fashion. A detailed blueprint of this organization is passed on to offspring.

Cells are the smallest functional units capable of independent reproduction. Many bacteria, for instance, can survive as single cells. The chemical molecules within each cell are organized to perform in concert.

#### Cells can be grown in culture and harvested

Cells can be gathered from their natural locations and grown inside laboratory containers. Appropriate food and environment must be provided for the cells to grow. Bacteria and yeast are very easy to grow in culture. Cells taken from plants, insects, and animals can also be grown, but are more difficult to care for.

After growth is complete, cells in culture can be harvested and studied.

#### Cloning

When a population of cells is prepared by growth from a single cell, all the cells in the population will be genetically identical. Such a population is called “clonal”. The process of creating a clonal population is called “cloning”. The purpose of streaking bacteria on agar is to generate single colonies, each arising from a single cell.

#### Looking inside cells

The molecules inside a cell each perform a given function. For instance, DNA molecules store information (like the hard drive in a computer). Proteins are the workhorses of the cell.

To study these molecules we prepare a clonal population from a cell type of interest, break open the cells, and sort the contents. For instance, it is fairly easy to separate all the proteins from all the DNA molecules.

Purifying a single species of protein out of the mixture of proteins found inside a cell type is also possible. Each type of protein has unique physical and chemical properties. These properties allow the separation of protein species *i.e.* based on size, charge, or hydrophobicity, for instance.

#### Special molecules, specialized functions

We will take a close look at three very special kinds of molecules found inside cells: DNA, RNA and proteins. Each of these molecules performs a different function. DNA molecules are like file cabinets in which information is stored. RNA helps to retrieve and execute the instructions which are stored in DNA. Proteins are designed to perform chemical chores inside (and often outside) the cell.

#### DNA: The universal template for biological information

The master “script” for each organism is encoded within its deoxyribonucleic acid (DNA). The information within the DNA molecule/s of each cell is sufficient to initiate every function that cell will perform.

DNA molecules are very long chains composed of repeating subunits. Each subunit (“nucleotide”) contains one of four possible bases protruding from its side:

ADENINE (“A”)	CYTOSINE (“C”)
THYMINE (“T”)	GUANINE (“G”)

Since nucleotides are joined head-to-tail, a long strand of DNA essentially consists of a chemical backbone with bases protruding along its side. The information carried by this molecule is encoded in the sequence of As, Gs, Cs and Ts along its length.

Some further points to note about DNA structure:

1. Because the subunits of DNA chains are joined head-to-tail, the sequence is directional *i.e.* “AACTG” is **not** the same as “GTCAA”. By convention, we write DNA sequence from the free 5' end of the backbone and work our way towards the other free end (3').

*i.e.* 5'...AACTG...3'

2. The protruding bases along the chain are free form spontaneous bonds with available bases on other DNA strands according to the following rules:

- (i) “A” pairs with “T”
- (ii) “C” pairs with “G”

Because of these rules, “A” and “T” are said to be complementary bases; “G” and “C” are also complementary.

- (iii) For two DNA strands to pair up, they must be complementary and run in opposite directions.

*i.e.* (5'...AGGTC...3') can pair with (5'...GACCT...3'). These two strands have complementary sequences. The double-stranded pair is written as follows:

5'...AGGTC...3'  
3'...TCCAG...5'

The above molecule contains five base pairs. Indeed, in nature, DNA almost always occurs in double-stranded form, the two strands containing complementary sequences.

3. DNA molecules are typically thousands, sometimes millions of base pairs long!! Sometimes the two ends of a DNA molecule are joined to form circular DNA.
4. Double-stranded DNA, in its native form, occurs as a coiled spring, or helix. Because it is two-stranded, it is often referred to as a double helix.

The architecture of DNA allows for a very simple strategy during reproduction: The two strands of each DNA molecule unwind and “unzip”; then, each strand allows a new complementary copy of itself to be made by an enzyme called “DNA polymerase”. This results in two daughter molecules, each double-stranded, and each identical to the parent molecule.

### **Proteins and RNA are the workhorses of the cell**

The biochemistry of life requires hundreds of very specific and efficient chemical interactions, all happening simultaneously. The major players in these interactions are short-lived protein and RNA molecules which can work together or independently to serve a variety of functions. Like DNA, RNA and proteins are also long chains of repeating units.

### **RNA**

RNA (ribonucleic acid), like DNA, consists of four types of building blocks strung together in a chain. It differs from DNA in the following respects:

The four bases in RNA are “A”, “G”, “C” and “U” (uracil); the pairing rules are the same as for DNA except that “A” pairs with “U”. Although RNA can pair with complementary RNA or DNA, in cells RNA is usually single-stranded. The sugar in the RNA backbone is ribose, not deoxyribose. RNA molecules are generally short, compared to DNA molecules; this is because each RNA is itself a copy of a short segment from a DNA molecule. The process of copying segments of DNA into RNA is called transcription, and is performed by a protein called RNA polymerase.

## Proteins

Proteins (more precisely, polypeptides) are also long, chain-like molecules but more structurally diverse than either DNA or RNA. This is because the subunits of proteins called amino acids, come in twenty different types. The exact sequence of amino acids along a polypeptide chain determines how that chain will “fold” into a compact structure. The precise 3-dimensional features of this structure, in turn, determine its function.

What a protein will **do** depends on the exact **sequence** of its amino acids.

In most cases, a protein will perform a single function. Very diverse functions can be performed by proteins: Some proteins, called “enzymes”, act as catalysts in chemical reactions; some carry signals from one part of a cell to another - or, in the case of “hormones”, from one cell to another; some proteins (“antibodies”) have the task of fighting intruders; many become integral parts of the various physical structures inside cells; and still others (“regulatory proteins”) police various activities within cells so as to keep them within legal limits.

## Linear code, three-dimensional consequences

DNA is the primary depot for information in living systems. As mentioned, this information is linear *i.e.* encoded in the sequence of “A”, “G”, “C”, “T” building blocks along the DNA molecule. This linear code can be passed on to offspring — because DNA can make exact copies of itself.

Short segments of each DNA molecule are chosen for transcription at any given time. These segments are called “genes”. The enzyme RNA polymerase copies the entire segment, base by base, assembling an RNA molecule which contains a sequence of “A”, “G”, “C” and “U” exactly complementary to the DNA sequence of the transcribed gene.

In addition to providing a master template for copying RNAs, DNA also contains sequence information which tells the RNA polymerase where to start transcribing a gene (“promoter”) and where to stop; how many copies it should make and when; and it can even embed certain information within the RNA sequence to determine the longevity and productivity of that RNA!

There are three major classes of RNAs copied off DNA templates: messenger RNAs, or mRNAs, which relay the sequence information required for assembling proteins; transfer RNAs, or tRNAs, which work in the assembly line for proteins; and RNAs which perform structural functions. For example, ribosomal RNAs, or rRNAs, help build the scaffolding for ribosomes, the factories where proteins are assembled.

mRNAs carry the sequence information for making proteins. Ribosomes read this sequence of nucleotides, by a process called “translation” into a sequence of amino acids. How is this accomplished? There are only four kinds of nucleotides, but twenty kinds of amino acids!

During translation, the ribosome reads 3 nucleotides at a time and assigns an amino acid to each successive “triplet”. [NOTE: Triplets are often referred to as “codons”.] Each amino acid is then attached to the end of the growing protein chain. There are 64 possible triplets, or codons. Thus, the linear information residing in DNA is used to assemble a linear sequence

of amino acids in a protein. This sequence, in turn, **will determine the way that protein will fold into a precise shape** with characteristic chemical properties.

In summary, the primary transfer of information within cells follows the order:

DNA >>> RNA>>> PROTEIN>>>>TRAIT

Although the information itself is linear, the implications are 3-dimensional. A fundamental assumption of recombinant DNA technology is that permanent and desirable changes in the functioning of living cells can be accomplished by changing the linear sequence of their DNA.

### **Genes are discrete files of DNA information**

A gene is a segment within a DNA molecule singled out for copying into RNA. Directly or indirectly, this RNA will perform a function. It is convenient to think of a gene, therefore, as a unit of function.

Many traits, such as bacterial resistance to an antibiotic, are governed by single genes. Most traits—such as the color of a rose, or the shape of a nose—are governed by several genes acting in concert.

Genes can vary in length: Some are only a few hundred base pairs long; some can be tens of thousands of base pairs long. A DNA molecule may carry from a handful to thousands of genes. A cell, in turn, may contain one or several DNA molecules (chromosomes). Thus the number of genes in a cell can vary greatly. *E.coli*, a bacterium, contains one DNA molecule with about five thousand genes on it. A human cell contains 46 DNA molecules carrying a total of about 100,000 genes.

All genes in a given cell are **not** copied into RNA (*i.e.* “expressed”) at the same time or at the same rate. Thus, when speaking of gene function, one refers to its “expression level”. This rate can be controlled by the cell, according to predetermined rules which are themselves written into the DNA.

An example: The cells in our bodies (all 100 trillion of them) each contain identical DNA molecules. Yet liver cells, for example, express only those genes required for liver function, whereas skin cells express a quite different subset of genes!

### **DNA can be cut into pieces with restriction enzymes**

Restriction enzymes are proteins made by bacteria as a defense against foreign, invading DNA (for example, viral DNA). Each restriction enzyme recognizes a unique sequence of typically 4–6 base pairs, and will cut any DNA whenever that sequence occurs.

For example, the restriction enzyme BamHI recognizes the sequence (5'..GGATCC..3') and cuts the DNA strand between the two G nucleotides in that sequence.

Restriction enzymes will cut DNA from any source, provided the recognition sequence is present. It does not matter if the DNA is of bacterial, plant or human origin.

### **Pieces of DNA can be joined by DNA ligase**

DNA ligase is an enzyme that “glues” pieces of DNA together, provided the ends are compatible.

Thus, a piece of human or frog or tomato DNA cut with BamHI can be easily joined to a piece of bacterial DNA also cut with BamHI. This allows the creation of recombinant DNAs *i.e.* hybrids, created by joining pieces of DNA from two different sources.

Genes can be cut out of human DNA, or plant DNA, and placed inside bacteria. For example, the human gene for the hormone insulin can be put into bacteria. Under the right conditions, these bacteria can make authentic human insulin!

### **Plasmids are small circular pieces of DNA**

Plasmids are small circular DNAs found inside some bacterial cells. They replicate their own DNA by “borrowing” the cells’ polymerases. Thus they can persist indefinitely inside cells without doing very much work of their own!

Because of their small size, plasmid DNAs are easy to extract and purify from bacterial cells. When cut with a restriction enzyme, they can be joined to foreign DNAs - from any source - which have been cut with the same enzyme.

The resulting hybrid DNAs can be re-introduced into bacterial cells by a procedure called transformation. Now the hybrid plasmids can perpetuate themselves in the bacteria just as before except that the foreign DNA which was joined to it is also being perpetuated. The foreign DNA gets a free ride, so to speak.

Every hybrid plasmid now contains a perfect copy of the piece of foreign DNA originally joined to it. We say that foreign piece of DNA has been “cloned”; the plasmid which carried the foreign DNA is called a cloning vehicle or vector.

In addition to their usefulness for cloning foreign genes, plasmids sometimes carry genes of their own. Bacteria die when exposed to antibiotics. However, antibiotic-resistance genes allow bacteria to grow in the presence of an antibiotic such as ampicillin. Such genes are often found on plasmids. When foreign DNA is inserted into such plasmids, and the hybrids introduced into bacterial cells by transformation, it is easy to select those bacteria that have received the plasmid—because they have acquired the ability to grow in the presence of the antibiotic, whereas all other bacterial cells are killed.

### **DNA libraries**

When DNA is extracted from a given cell type, it can be cut into pieces and the pieces can be cloned en masse into a population of plasmids. This process produces a population of hybrid (*i.e.* recombinant) DNAs. After introducing these hybrids back into cells, each transformed cell will have received and propagated one unique hybrid. Every hybrid will contain the same vector DNA but a different “insert” DNA.

If there are 1,000 different DNA molecules in the original mixture, 1,000 different hybrids will be formed; 1,000 different transformant cells will be recovered, each carrying one of the original 1,000 pieces of genetic information. Such a collection is called a DNA library. If the original extract came from human cells, the library is a human library.

Individual DNAs of interest can be fished out of such a library by screening the library with an appropriate probe.

## Appendix C

### Sterile Technique

With any type of microbiology technique (*i.e.* working with and culturing bacteria), it is important to not introduce contaminating bacteria into the experiment. Because contaminating bacteria are ubiquitous and are found on fingertips, bench tops, etc., it is important to minimize contact with these contaminating surfaces. When students are working with the inoculation loops, pipettors, and agar plates, you should stress that the round circle at the end of the loop, the tip of the pipettor, and the surface of the agar plate should not be touched or placed onto contaminating surfaces. While some contamination will not likely ruin the experiment, students would benefit from an introduction to the idea of sterile technique. Using sterile technique is also an issue of human cleanliness and safety.

### Working with *E. coli*

The host organism, an *E. coli* K-12 strain, and the vector containing the recombinant GFP protein and the subsequent transformants created by their combination, are not pathogenic organisms like the *E. coli* O157:H7 strain that has been in the news. However, handling of the *E. coli* K-12 entities of the GFP Purification Kit requires the use of Standard Microbiological Practices. These practices include but are not limited to the following: Work surfaces are decontaminated with 10% bleach once a day and after any spill of viable material. All contaminated liquid or solid wastes are decontaminated before disposal. Persons wash their hands: (i) After they handle materials involving organisms containing recombinant DNA molecules, and (ii) before exiting the laboratory. All procedures are performed carefully to minimize the creation of aerosols. Mechanical pipetting devices are used; mouth pipetting is prohibited. Eating, drinking, smoking, and applying cosmetics are not permitted in the work area.

### Decontamination and Disposal

If an autoclave is not available, all solutions and components (loops and pipettes) that have come in contact with bacteria can be placed in a fresh 10% bleach solution for at least 20 minutes for sterilization. A shallow pan of this solution should be placed at every lab station. No matter what you choose, all used loops and pipettes should be collected for sterilization. Sterilize Petri dishes by covering the agar with 10% bleach solution. Let it stand for 1 hour or more. Once sterilized, the agar plates can be double bagged and treated as normal trash. Safety glasses are recommended when using bleach solutions.

## Appendix D

### Gene Regulation. One Gene: One Protein.

Our bodies contain thousands of different proteins which perform many different jobs. Digestive enzymes are proteins; some of the hormone signals that run through our bodies and the antibodies protecting us from disease are proteins. The information for assembling a protein is carried in our DNA. The section of DNA which contains the code for making a protein is called a gene. There are over 100,000 genes in the human genome. Each gene codes for a unique protein: one gene-one protein. The gene which makes a digestive enzyme in your mouth is different from one which makes an antibody or the pigments that color your eyes.

Organisms regulate expression of their genes and ultimately the amounts and kinds of proteins present within their cells for a myriad of reasons including developmental, cellular specialization and adaptation to the environment. Gene regulation not only allows for adaptation to differing conditions, but also prevents wasteful overproduction of unneeded proteins which would put the organism at a competitive disadvantage. The genes involved in the transport and breakdown (catabolism) of food are good examples of highly regulated genes. For example, the sugar arabinose is both a source of energy and a source of carbon. *E. coli* bacteria produce three enzymes (proteins) needed to digest arabinose as a food source. The genes which code for these enzymes are not expressed when arabinose is absent, but they are expressed when arabinose is present in their environment. How is this so?

Regulation of the expression of proteins often occurs at the level of transcription from DNA into RNA. This regulation takes place at a very specific location on the DNA template, called a promoter, where RNA polymerase sits down on the DNA and begins transcription of the gene. In bacteria, groups of related genes are often clustered together and transcribed into RNA from one promoter. These clusters of genes controlled by a single promoter are called operons.

The three genes (*araB*, *araA* and *araD*) that code for three digestive enzymes involved in the breakdown of arabinose are clustered together in what is known as the arabinose operon. These three proteins are dependent on initiation of transcription from a single promoter, (P<sub>BAD</sub>). Transcription of these three genes requires the simultaneous presence of the DNA template (promoter and operon), RNA polymerase, a DNA binding protein called AraC, and arabinose. AraC binds to the DNA at the binding site for the RNA polymerase (the beginning of the arabinose operon). When arabinose is present in the environment, bacteria take it up. Once inside, the arabinose interacts directly with AraC which is bound to the DNA. The interaction causes AraC to change its shape which in turn promotes (actually helps) the binding of RNA polymerase and the three genes B, A, and D, are transcribed. Three enzymes are produced, they do their job, and eventually the arabinose runs out. In the absence of arabinose, the AraC returns to its original shape and transcription is shut off.

The DNA code of the pGLO plasmid has been engineered to incorporate aspects of the arabinose operon. Both the promoter (P<sub>BAD</sub>) and the *araC* gene are present. However, the genes which code for arabinose catabolism, *araB*, A and D, have been replaced by the single gene which codes for the Green Fluorescent Protein (GFP). Therefore, in the presence of arabinose, AraC protein promotes the binding of RNA polymerase and GFP is produced. Cells fluoresce a brilliant green color as they produce more and more protein. In the absence of arabinose, AraC no longer facilitates the binding of RNA polymerase and the GFP gene is not transcribed. When the GFP protein is not made, bacteria colonies will appear to have a wild type (natural) phenotype - of white colonies with no fluorescence.

This is an excellent example of the central dogma of molecular biology in action; DNA>RNA>PROTEIN>TRAIT.



# The Arabinose Operon

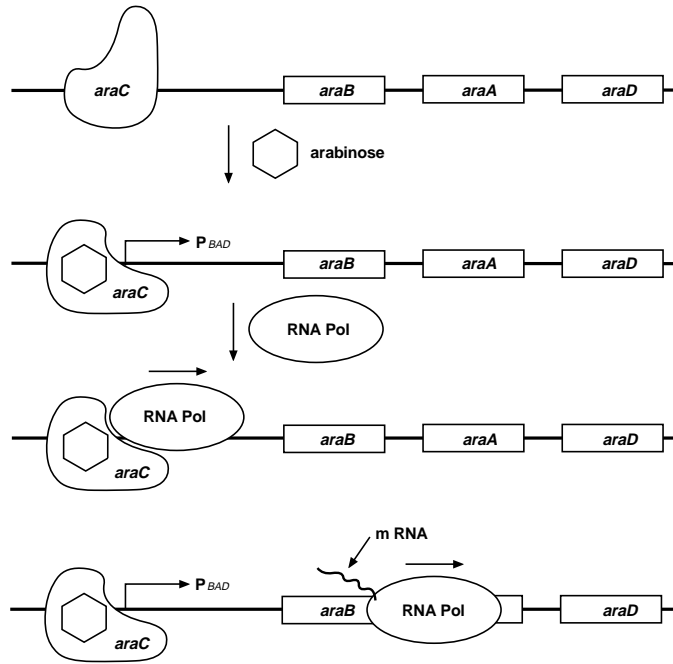

# Expression of Green Fluorescent Protein

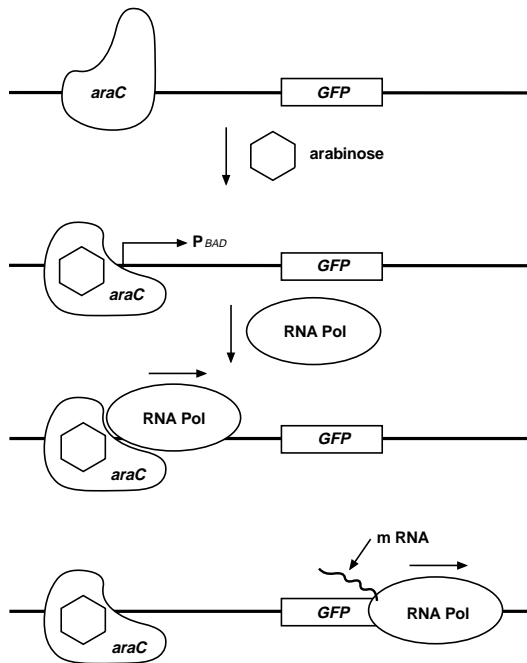

**BIO-RAD**

**Bio-Rad  
Laboratories**

*Life Science  
Group*

**Website** [www.bio-rad.com](http://www.bio-rad.com) **Bio-Rad Laboratories Main Office** 2000 Alfred Nobel Drive, Hercules, CA 94547, Ph. (510) 741-1000, Fx. (510) 741-5800  
**Also in: Australia** Ph. 02-9914-2800, Fx. 02-9914-2889 **Austria** Ph. (1)-877 89 01, Fx. (1) 876 56 29 **Belgium** Ph. 09-385 55 11, Fx. 09-385 65 54  
**Canada** Ph. (905) 712-2771, Fx. (905) 712-2990 **China** Ph. (86-10) 2046622, Fx. (86-10) 2051876 **Denmark** Ph. 39 17 9947, Fx. 39 27 1698  
**Finland** Ph. 90 804 2200, Fx. 90 804 1100 **France** Ph. (1) 43 90 46 90, Fx. (1) 46 71 24 67 **Germany** Ph. 089 31884-0, Fx. 089 31884-100  
**Hong Kong** Ph. 7893300, Fx. 7891257 **India** Ph. 91-11-461-0103, Fx. 91-11-461-0765 **Israel** Ph. 03 951 4127, Fx. 03 951 4129  
**Italy** Ph. 02-21609.1, Fx. 02-21609.399 **Japan** Ph. 03-5811-6270, Fx. 03-5811-6272 **The Netherlands** Ph. 0313 18-540666, Fx. 0313 18-542216  
**New Zealand** Ph. 09-443 3099, Fx. 09-443 3097 **Singapore** Ph. (65) 272-9877, Fx. (65) 273-4838 **Spain** Ph. (91) 661 70 85, Fx. (91) 661 96 98  
**Sweden** Ph. 46 (0) 8 627 50 00, Fx. 46 (0) 8 627 54 00 **Switzerland** Ph. 01-809 55 55, Fx. 01-809 55 00  
**United Kingdom** Ph. 0800 181134, Fx. 01442 259118